



# WOOD FENCE PRODUCTS

06/01/26

# SALES TERMS AND CONDITIONS



## ACCOUNT SETUP

We only sell to the fence trade, therefore we require all customers to properly complete an account application prior to being set up and prior to receiving any pricing, catalogs or literature to ensure that we do not give pricing or information to an end user. You may request a credit line from us within the account application. You may also assign your password and give us your email address so you may access your account on our website.

## CATALOG CHANGES

As you will notice, this catalog is very comprehensive and even though we go to extreme efforts to keep it updated it would be impossible to update it for every change that may occur. Therefore, product information and prices shown are subject to change without notice. We are also not responsible for typographical errors.

## FREIGHT/DELIVERY

There will be a shipping charge if a delivery does not meet a minimum order value. A customer may choose to have it shipped via outside carrier or UPS, at which time the appropriate fee will be attached.

Unless prior arrangements have been made, we require the customer's presence and assistance with receiving our delivery.

## RETURN POLICY

Any customer returning material must first contact Eastern for a return authorization within five days. **No returns on wood or vinyl products.** Any returns shipped without authorization will not be accepted. Eastern requires the returned goods to be properly packaged and in the same condition as was originally received. Eastern reserves the right to inspection on returned products prior to approving the final credit memo.

**A minimum restocking charge of 20% (minimum \$35.00) will be charged on all material returned unless the return results from our error.**

## SPECIAL ORDERS

Eastern prefers to receive a written purchase order when a special or non-stock item is being purchased. However, as a convenience to our customers, we will accept verbal orders. We may require a non-refundable 50% deposit or advance payment depending upon the nature of the order. Once ordered, there can be no cancellation or return on special orders.

## QUOTATIONS, SPECIFICATIONS & CERTIFICATIONS

Quotations will be given based upon the customer's breakdown of the material requirements. Eastern will gladly assist in helping you with the quoting of material, however, we are not responsible for products ordered incorrectly.

When material being purchased is required to meet certain specifications and/or certifications will be required, we must be notified at the time the order is being placed.

## TRADEMARK REPRODUCTION RIGHTS

Eastern Wholesale Fence LLC ©2026 All Rights Reserved. Eastern, the Eastern Logo, Illusions, Illusions Vinyl Railing System, Grand Illusions Advantage, Pen Pals, Ornamental Aluminum, System 21, Uni-Weld, Eastern White Cedar, Everstrong, Internal Slide Gate, Investment Grade and Marine Link logos are all trademarks of Eastern Wholesale Fence Co., Inc., registered in the U.S. and other countries. No part of this publication may be reproduced, stored in a retrieval system or transmitted in any form or by any means, electronic, mechanical, photocopying, recording, scanning or otherwise, except as permitted under Sections 107 or 108 of the 1976 United States Copyright Act, without the prior written permission of Eastern Wholesale Fence Co., Inc.



**Eastern Wholesale Fence LLC • 800-339-3362**

**266 Middle Island Rd. Medford, NY 11763 • [www.easternfence.com](http://www.easternfence.com)**

# TABLE OF CONTENTS



## INFORMATION

Sales Terms and Conditions .....	F-2
Table of Contents .....	F-3
Why Eastern Wood Fence? .....	F-4
Ordering Checklist.....	F-6
Wood Fence Ordering Sheet.....	F-7



## PANELS

Moulded Stockade Panels.....	F-8
Spruce Stockade.....	F-9
Moulded Cedar Stockade .....	F-10
Moulded Cedar Picket .....	F-12
Spaced Picket Panels.....	F-13
Solid Panels.....	F-24
Solid Shaped Panels .....	F-38
One Piece Tongue & Groove Panels.....	F-46
Tongue & Groove Panels With Toppers .....	F-50
Classic Victorian Picket .....	F-57
Horizontal Cedar Panels .....	F-65
Board on Board.....	F-69
Heavy Lattice.....	F-76

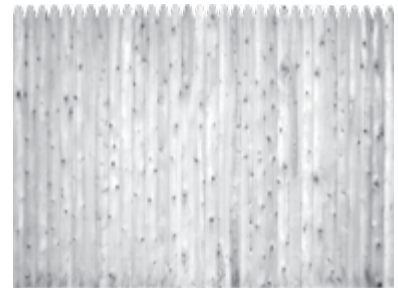

## POST & RAIL

Diamond Post & Rail.....	F-82
Pressure Treated & White Cedar Post & Rail.....	F-83
Western Red Cedar Post & Rail .....	F-84
Slip Board Post & Rail.....	F-84

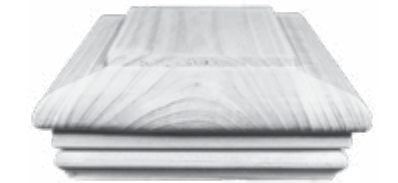

## OTHER

Wood Posts and Caps .....	F-85
Fence Boards and Backrails.....	F-86
Privacy Gates.....	F-87
Arbors & Pergolas.....	F-88
Standard Post Top Finials .....	F-89
Gate Hardware .....	F-90
Ornamental Gate Hardware .....	F-94



# Why Eastern Wood Fence?



## About Our Company

If you're looking for distinctive creative styles and consistent quality wood fencing, look no further. Eastern Wood Fence products are skillfully hand crafted in our own factory with one of the fastest delivery rates in the nation.

Our huge selection features tongue & groove privacy fence, Red Cedar picket fence, lattice fence, solid privacy fence panels, shaped solid privacy panels, spaced picket fencing, spruce or cedar stockade fence, board on board fencing, gates, toppers, arbors, pergolas, custom designed hardware, and much much more...

“With the thumping sounds of air guns popping and saw-blades whizzing, another premium cedar fence section takes form.” A form that we have been creating for over 55 years. Eastern Wood Fence brand was created by a company that started selling wholesale wood fence products in 1971.

Today, we are one of the fastest, highest quality wood fence fabricators in the industry. We employ only the finest wood craftsmen and artisans to create the custom wood fence products known throughout the country for quality and workmanship.

Our Wood Fencing Products are sold through a network of quality professional fence dealers throughout the northeastern United States. We would ask that you quite simply contact your local Eastern Fence dealer and ask for “Eastern White Cedar Brand” by name.



# Why Eastern Wood Fence?



Carefully created with an old world charm,  
Eastern Wood Fence products are the perfect landscape accent.

# ORDERING CHECKLIST



## Please Have Your Material List Ready To Go When You Call

Being that Eastern Wood Fence products are sold wholesale to the trade, it is highly suggested that you have a material list for your order prior to calling. Please feel free to use this checklist and the "WOOD ORDERING SHEET" as a guide prior to your call.

### Sections

The code, height, and species of wood required are all very important when ordering.

### Picket & Board Top Styles

Picket and board top styles are chosen for any solid or spaced picket gates and sections. (Not used for Tongue & Groove or Classic Victorian Picket Sections.)

#### PICKET & BOARD TOP STYLES

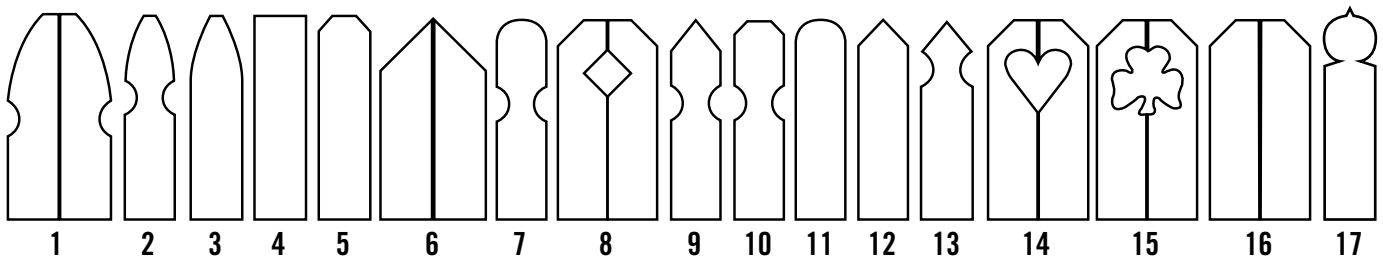

### Gates

Walk gates, drive gates, matching gates, accent gates.

### Arbors & Pergolas

Don't forget to spruce up the entranceways with arbors and pergolas!

### Posts - Wood Species

- Cedar
- Pressure treated

### Post Caps

Post caps or finials

### Hardware

- Hinges - (One pair per gate)
  - Spring loaded are also available
- Latches (Magnetic latches, hatchet latches, and gravity latches are all available)
- Drop Rods (Double drive gates need two drop rods)
- Handles
- Spring Closers (if hinges are not spring loaded)

## Order Process

Orders may be submitted by calling 800-339-3362, faxing to (631)-698-6408 or (800)-788-0411, or e-mailing to [sales@easternfence.com](mailto:sales@easternfence.com).



# MOULDED STOCKADE PANELS



**S346 or C346  
6' High Moulded  
Spruce or Cedar Stockade**



**C346S  
6' High Scalloped Moulded  
Cedar Stockade**

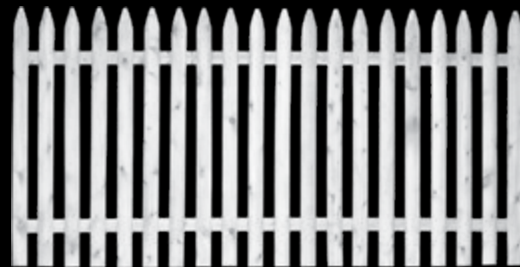

**CPS344  
4' High Moulded  
Cedar Spaced Picket**

# MOULDED 3/4" SPRUCE STOCKADE

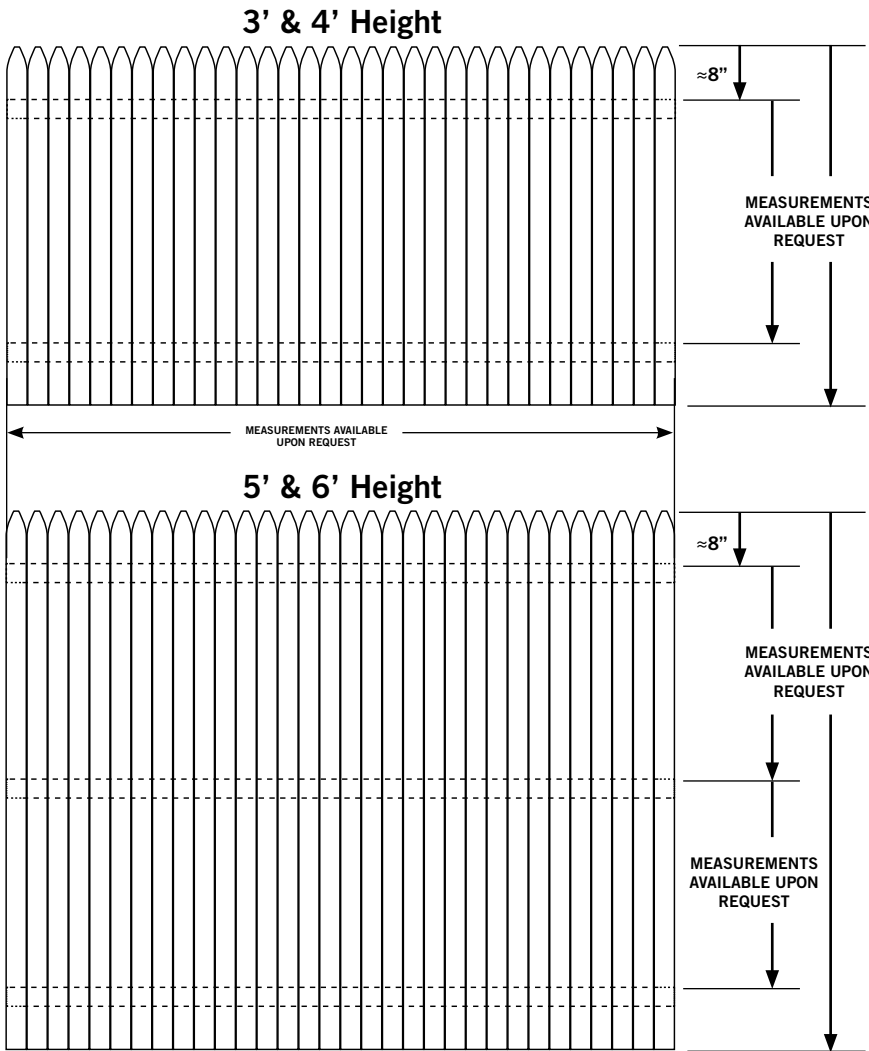

## MOULDED 3/4" SPRUCE STOCKADE

4', 5', 6' Height Spruce Stockade Panels

BOARDS	Nominal 3/4" x 3" / 27 Per Section
SPECIES	Spruce
NAILING	STANDARD: End pickets are doubled nailed and the inside pickets are single nailed OPTIONAL: Double nailing of inside pickets is available upon request (Add \$)
NAILS	Aluminum Spiral Nails
WIDTH	96" Nominal (Approx. 95" - 96")
RAILS	STANDARD: 2" x 3" Nominal Spruce
NOTE	Eastern Wholesale Fence is currently a distributor of spruce stockade and not the manufacturer. Measurements and specs are approximate and vary based upon suppliers. Please call if exact specifications are needed.

## SPRUCE BACKRAILS

Item #	Backrails	Description	Each
S344	SPRUCE 4'H   Solid   Spruce Backrails   Spruce Pickets		
S345	SPRUCE 5'H   Solid   Spruce Backrails   Spruce Pickets		
S346	SPRUCE 6'H   Solid   Spruce Backrails   Spruce Pickets		
S348	SPRUCE 8'H   Solid   Spruce Backrails   Spruce Pickets		

**PRICING SUBJECT TO CHANGE WITHOUT NOTICE**

**PLEASE NOTE: ONCE DELIVERED, EASTERN WOOD FENCE IS NON-REFUNDABLE.**

Wood fence is a natural product and natural weathering including splitting, warping, twisting, checking, raised grain, swelling, shrinkage, surface mold and/or mildew, fungi, or any other physical property of the wood including but not limited to knots can occur.

# MOULDED 3/4" STOCKADE WHITE CEDAR

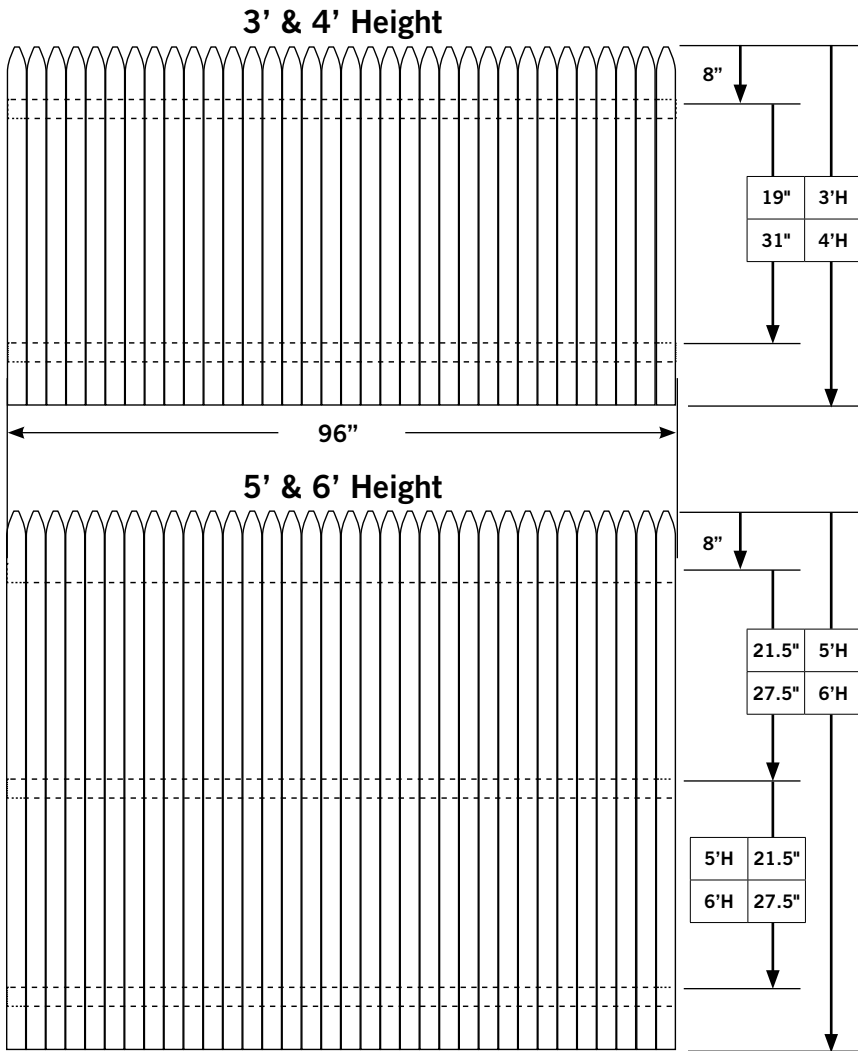

## MOULDED 3/4" WHITE CEDAR STOCKADE

### 3', 4', 5', 6' Height White Cedar Stockade

BOARDS	Nominal 1" x 3" / 34 Per Section
SPECIES	White Cedar
NAILING	TOP AND BOTTOM RAILS: Double Nailed MID-RAIL: End pickets are doubled nailed and the inside pickets are single nailed
NAILS	Aluminum Spiral Nails
WIDTH	96" Nominal (Approx. 96")
RAILS	STANDARD: 2" x 3" Nominal Cedar OPTIONAL: 2" x 3" Nominal Spruce OPTIONAL: Dowelled backrails. (Measurements may deviate from standard. Call for pricing and info)

## SPRUCE BACKRAILS

Item #	Backrails	Description				Each
C343	SPRUCE 3'H	Solid	Spruce Backrails	Cedar Boards		
C344	SPRUCE 4'H	Solid	Spruce Backrails	Cedar Boards		
C345	SPRUCE 5'H	Solid	Spruce Backrails	Cedar Boards		
C346	SPRUCE 6'H	Solid	Spruce Backrails	Cedar Boards		
C348	SPRUCE 8'H	Solid	Spruce Backrails	Cedar Boards		

## CEDAR BACKRAILS

Item #	Backrails	Description				Each
C343CB	CEDAR 3'H	Solid	Cedar Backrails	Cedar Boards		
C344CB*	CEDAR 4'H	Solid	Cedar Backrails	Cedar Boards	STOCKING ITEM	
C345CB	CEDAR 5'H	Solid	Cedar Backrails	Cedar Boards		
C346CB*	CEDAR 6'H	Solid	Cedar Backrails	Cedar Boards	STOCKING ITEM	
C348CB	CEDAR 8'H	Solid	Cedar Backrails	Cedar Boards		

**PLEASE NOTE: ONCE DELIVERED, EASTERN WOOD FENCE IS NON-REFUNDABLE.**

Wood fence is a natural product and natural weathering including splitting, warping, twisting, checking, raised grain, swelling, shrinkage, surface mold and/or mildew, fungi, or any other physical property of the wood including but not limited to knots can occur.

# MOULDED 3/4" STOCKADE WHITE CEDAR SCALLOPED

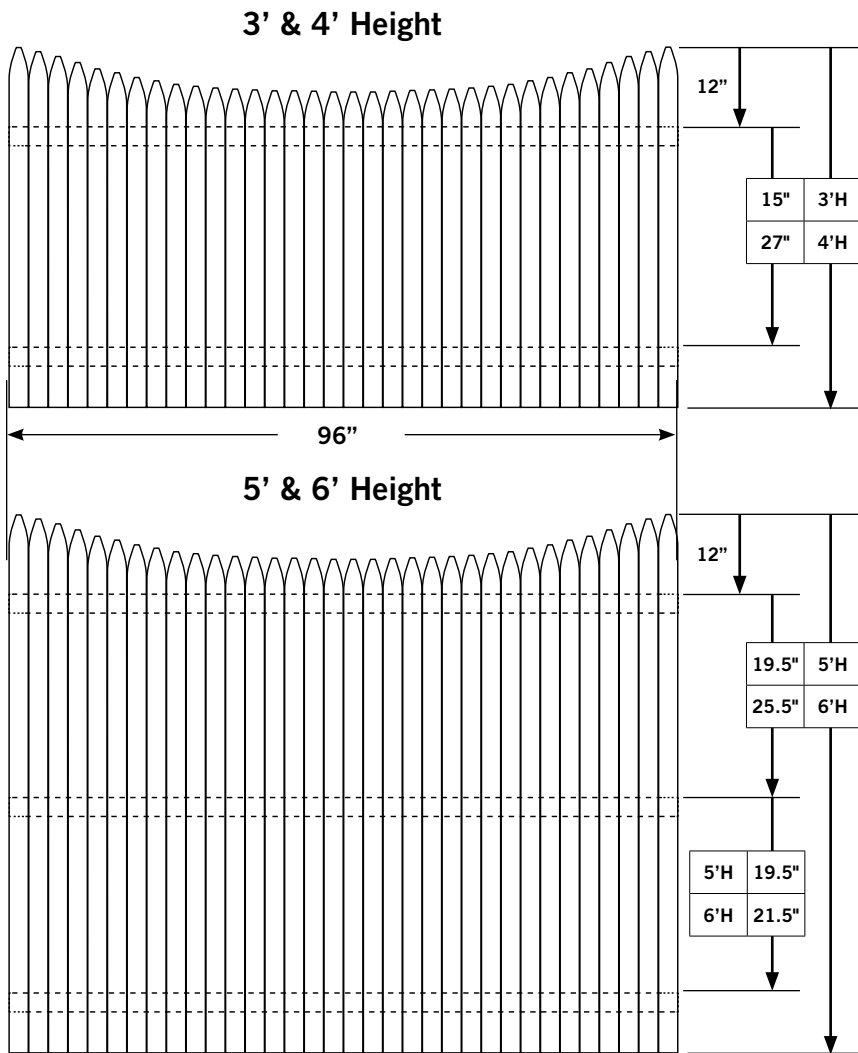

## MOULDED 3/4" WHITE CEDAR SCALLOPED STOCKADE

3', 4', 5', 6' Height White Cedar Scalloped

BOARDS	Nominal 1" x 3" / 34 Per Section
SPECIES	White Cedar
NAILING	TOP AND BOTTOM RAILS: Double Nailed MID-RAIL: End pickets are doubled nailed and the inside pickets are single nailed
NAILS	Aluminum Spiral Nails
WIDTH	96" Nominal (Approx. 96")
RAILS	STANDARD: 2" x 3" Nominal Cedar OPTIONAL: 2" x 3" Nominal Spruce OPTIONAL: Dowelled backrails. (Measurements may deviate from standard. Call for pricing and info)

### SPRUCE BACKRAILS

Item #	Backrails	Description	Each
C344S	SPRUCE 4'H   Solid   Spruce Backrails	Cedar Boards   Scalloped	
C345S	SPRUCE 5'H   Solid   Spruce Backrails	Cedar Boards   Scalloped	
C346S	SPRUCE 6'H   Solid   Spruce Backrails	Cedar Boards   Scalloped	
C348S	SPRUCE 8'H   Solid   Spruce Backrails	Cedar Boards   Scalloped	

### CEDAR BACKRAILS

Item #	Backrails	Description	Each
C344SCB	CEDAR 4'H   Solid   Cedar Backrails	Cedar Boards   Scalloped	
C345SCB	CEDAR 5'H   Solid   Cedar Backrails	Cedar Boards   Scalloped	
C346SCB	CEDAR 6'H   Solid   Cedar Backrails	Cedar Boards   Scalloped	
C348SCB	CEDAR 3'H   Solid   Cedar Backrails	Cedar Boards   Scalloped	

**PLEASE NOTE: ONCE DELIVERED, EASTERN WOOD FENCE IS NON-REFUNDABLE.**

Wood fence is a natural product and natural weathering including splitting, warping, twisting, checking, raised grain, swelling, shrinkage, surface mold and/or mildew, fungi, or any other physical property of the wood including but not limited to knots can occur.

# MOULDED STOCKADE PICKET

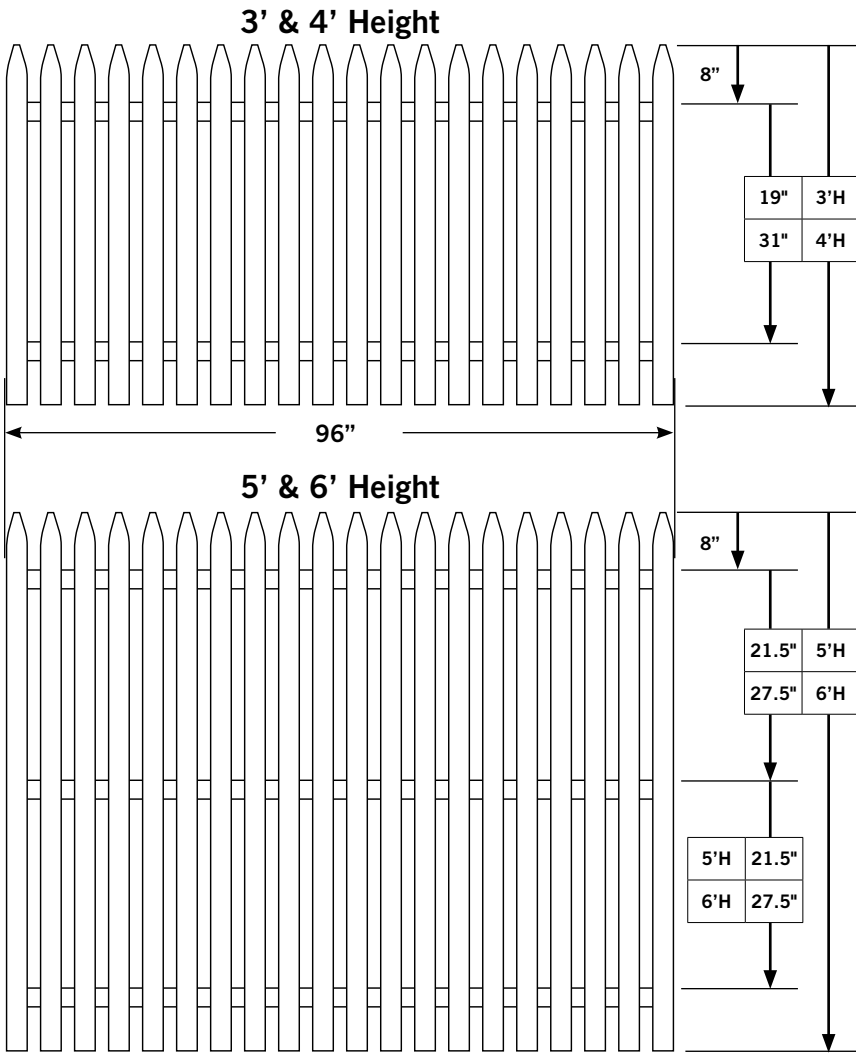

## MOULDED WHITE CEDAR STOCKADE PICKET

### 3', 4', 5', 6' Height White Cedar Stockade

BOARDS	Nominal 1" x 3" / 18 Per Section
SPACING	Nominal 1-3/4" to 1-7/8"
SPECIES	Red Cedar
NAILING	TOP AND BOTTOM RAILS: Double Nailed MID-RAIL: End pickets are doubled nailed and the inside pickets are single nailed
NAILS	Aluminum Spiral Nails
WIDTH	96"
RAILS	STANDARD: 2" x 3" Nominal Cedar OPTIONAL: 2" x 3" Nominal Spruce OPTIONAL: Dowelled backrails. (Measurements may deviate from standard. Call for pricing and info)
GATES	Matching gates available. Please CALL for more information.

## SPRUCE BACKRAILS

Item #	Backrails	Description	Each
CPS343	SPRUCE 3'H Spaced	Spruce Backrails   Cedar Boards	
CPS344	SPRUCE 4'H Spaced	Spruce Backrails   Cedar Boards	
CPS345	SPRUCE 5'H Spaced	Spruce Backrails   Cedar Boards	
CPS346	SPRUCE 6'H Spaced	Spruce Backrails   Cedar Boards	

## CEDAR BACKRAILS

Item #	Backrails	Description	Each
CPS343CB	CEDAR 3'H Spaced	Cedar Backrails   Cedar Boards	
CPS344CB*	CEDAR 4'H Spaced	Cedar Backrails   Cedar Boards	STOCKING ITEM
CPS345CB	CEDAR 5'H Spaced	Cedar Backrails   Cedar Boards	
CPS346CB	CEDAR 6'H Spaced	Cedar Backrails   Cedar Boards	

**MATCHING GATES AVAILABLE**

**PLEASE NOTE: ONCE DELIVERED, EASTERN WOOD FENCE IS NON-REFUNDABLE.**

Wood fence is a natural product and natural weathering including splitting, warping, twisting, checking, raised grain, swelling, shrinkage, surface mold and/or mildew, fungi, or any other physical property of the wood including but not limited to knots can occur.

# SPACED PICKETS - POPULAR STYLES



## POPULAR SPACED PICKET PANELS



101



102



103



350



352



401



402

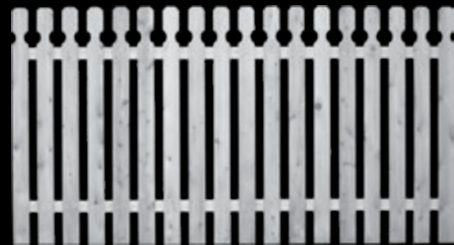

110



111



112

# SPACED PICKET - 101

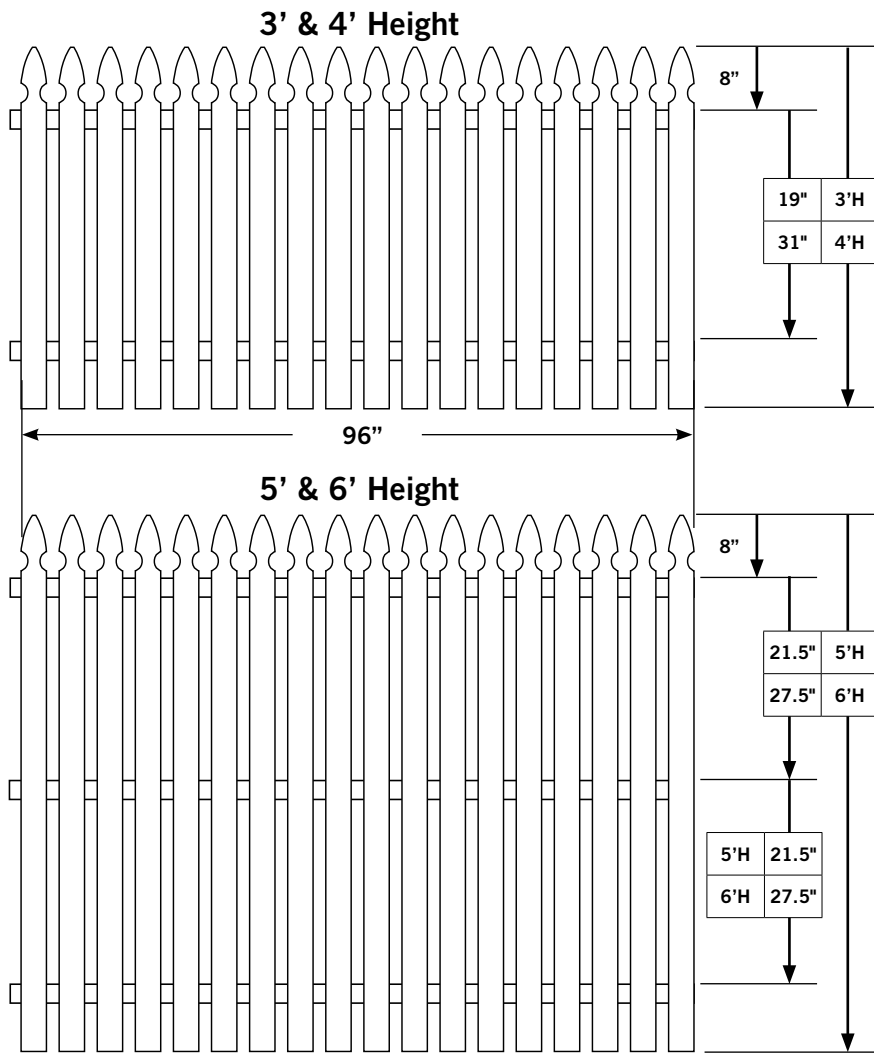

## 101 STYLE SPACED PICKET

3', 4', 5', 6' Height #1 Cedar Spaced Picket Fence with #2 Picket Tops

BOARDS	Nominal 1" x 4" / 18 Per Section
SPACING	Nominal 1-3/4" to 1-7/8"
SPECIES	White Cedar
NAILING	Double Nailed
NAILS	Aluminum Spiral Nails
WIDTH	96" Exact
RAILS	STANDARD: 2" x 3" Nominal Cedar OPTIONAL: 2" x 3" Nominal Spruce OPTIONAL: Dowelled backrails. (Measurements may deviate from standard. Call for pricing and info)
TABS	STANDARD: Left side (See diagram ←) OPTIONAL: No tabs (ADD \$) OPTIONAL: Right side (ADD \$) OPTIONAL: Both sides (ADD \$)
GATES	Matching gates available. Please CALL for more information

### PICKET TOP STYLES

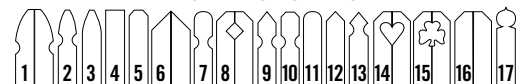

## SPRUCE BACKRAILS

Item #	Backrails	Description						Each
3361-101	SPRUCE 3'H	Spaced	Spruce Backrails	Cedar	#2 Picket Tops	Style 101		
4361-101	SPRUCE 4'H	Spaced	Spruce Backrails	Cedar	#2 Picket Tops	Style 101		
5361-101	SPRUCE 5'H	Spaced	Spruce Backrails	Cedar	#2 Picket Tops	Style 101		
6361-101	SPRUCE 6'H	Spaced	Spruce Backrails	Cedar	#2 Picket Tops	Style 101		

## CEDAR BACKRAILS

Item #	Backrails	Description						Each
3371-101	CEDAR 3'H	Spaced	Cedar Backrails	Cedar	#2 Picket Tops	Style 101		
4371-101	CEDAR 4'H	Spaced	Cedar Backrails	Cedar	#2 Picket Tops	Style 101		
5371-101	CEDAR 5'H	Spaced	Cedar Backrails	Cedar	#2 Picket Tops	Style 101		
6371-101	CEDAR 6'H	Spaced	Cedar Backrails	Cedar	#2 Picket Tops	Style 101		

**MATCHING GATES AVAILABLE**

**PLEASE NOTE: ONCE DELIVERED, EASTERN WOOD FENCE IS NON-REFUNDABLE.**

Wood fence is a natural product and natural weathering including splitting, warping, twisting, checking, raised grain, swelling, shrinkage, surface mold and/or mildew, fungi, or any other physical property of the wood including but not limited to knots can occur.

# SPACED PICKET - 102

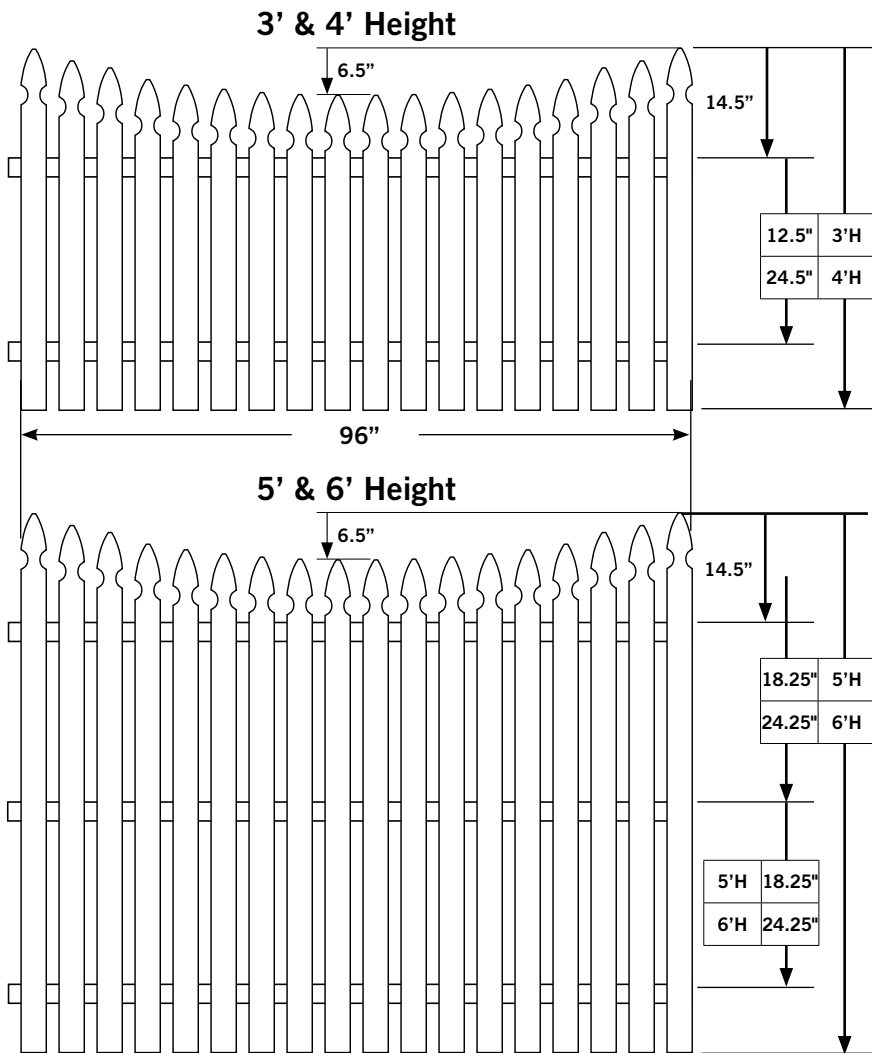

## 102 STYLE SPACED PICKET

3', 4', 5', 6' Height #1 Cedar Spaced Picket Fence with #2 Picket Tops

BOARDS	Nominal 1" x 4" / 18 Per Section
SPACING	Nominal 1-3/4" to 1-7/8"
SPECIES	White Cedar
NAILING	Double Nailed
NAILS	Aluminum Spiral Nails
WIDTH	96" Exact
RAILS	STANDARD: 2" x 3" Nominal Cedar OPTIONAL: 2" x 3" Nominal Spruce OPTIONAL: Dowelled backrails. (Measurements may deviate from standard. Call for pricing and info)
TABS	STANDARD: Left side (See diagram ←) OPTIONAL: No tabs OPTIONAL: Right side OPTIONAL: Both sides
GATES	Matching gates available. Please CALL for more information

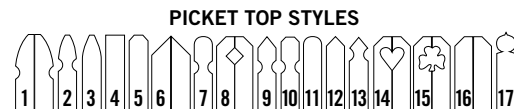

### SPRUCE BACKRAILS

Item #	Backrails	Description	Each
3361-102	SPRUCE 3'H   Spaced	Spruce Backrails   Cedar   #2 Picket Tops   Style 102	
4361-102	SPRUCE 4'H   Spaced	Spruce Backrails   Cedar   #2 Picket Tops   Style 102	
5361-102	SPRUCE 5'H   Spaced	Spruce Backrails   Cedar   #2 Picket Tops   Style 102	
6361-102	SPRUCE 6'H   Spaced	Spruce Backrails   Cedar   #2 Picket Tops   Style 102	

### CEDAR BACKRAILS

Item #	Backrails	Description	Each
3371-102	CEDAR 3'H   Spaced	Cedar Backrails   Cedar   #2 Picket Tops   Style 102	
4371-102	CEDAR 4'H   Spaced	Cedar Backrails   Cedar   #2 Picket Tops   Style 102	
5371-102	CEDAR 5'H   Spaced	Cedar Backrails   Cedar   #2 Picket Tops   Style 102	
6371-102	CEDAR 6'H   Spaced	Cedar Backrails   Cedar   #2 Picket Tops   Style 102	

**MATCHING GATES AVAILABLE**

**PLEASE NOTE: ONCE DELIVERED, EASTERN WOOD FENCE IS NON-REFUNDABLE.**

Wood fence is a natural product and natural weathering including splitting, warping, twisting, checking, raised grain, swelling, shrinkage, surface mold and/or mildew, fungi, or any other physical property of the wood including but not limited to knots can occur.

# SPACED PICKET - 103

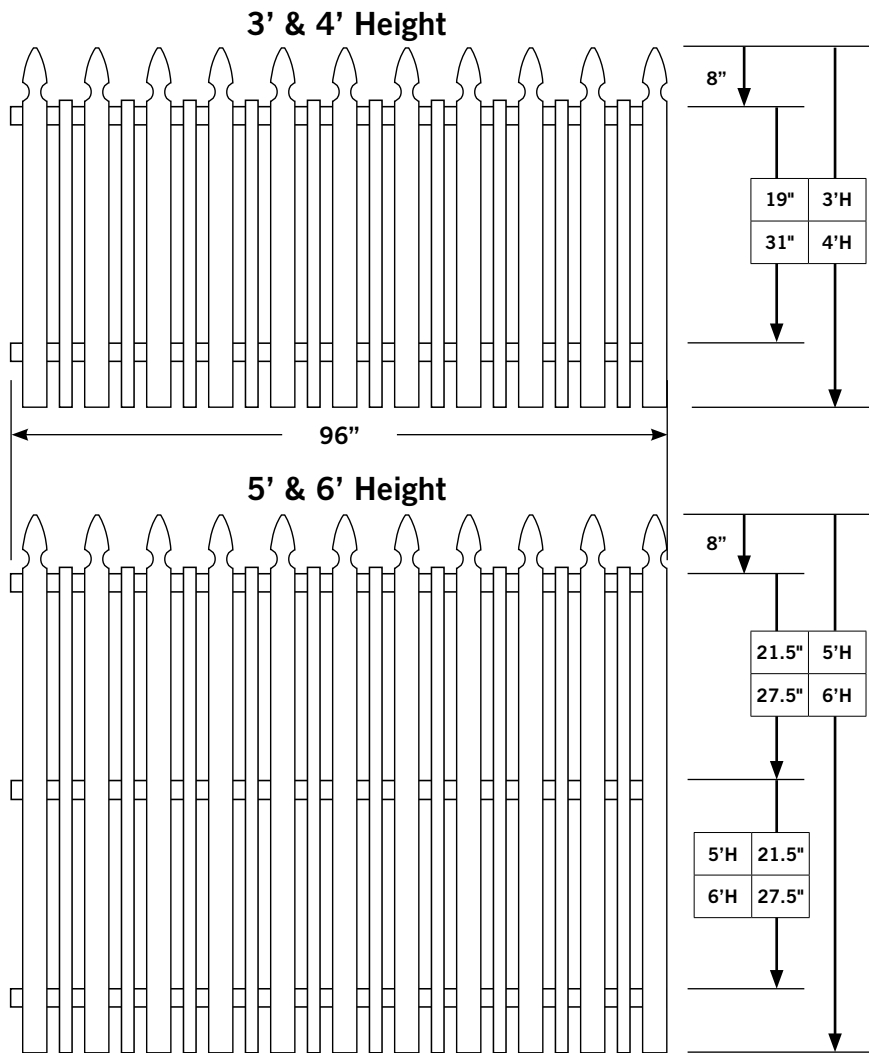

## 103 STYLE SPACED PICKET

3', 4', 5', 6' Height #1 Cedar Spaced Picket Fence with #2 and #4 Picket Tops

BOARDS	Nominal 1" x 4" / 11 Per Section Nominal 1" x 2" / 10 Per Section
SPACING	Nominal 1-3/4" to 1-7/8"
SPECIES	White Cedar
NAILING	Double Nailed
NAILS	Aluminum Spiral Nails
WIDTH	96" Exact
RAILS	STANDARD: 2" x 3" Nominal Cedar OPTIONAL: 2" x 3" Nominal Spruce OPTIONAL: Dowelled backrails - (Measurements may deviate from standard. Call for pricing and info)
TABS	STANDARD: Left side (See diagram ←) OPTIONAL: No tabs OPTIONAL: Right side OPTIONAL: Both sides
GATES	Matching gates available. Please CALL for more information

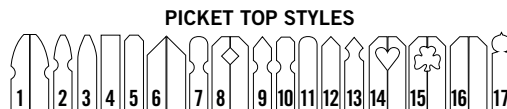

### SPRUCE BACKRAILS

Item #	Backrails	Description	Each
3361-103	SPRUCE 3'H   Spaced	Spruce Backrails   Cedar   #2 and #4 Picket Tops   Style 103	
4361-103	SPRUCE 4'H   Spaced	Spruce Backrails   Cedar   #2 and #4 Picket Tops   Style 103	
5361-103	SPRUCE 5'H   Spaced	Spruce Backrails   Cedar   #2 and #4 Picket Tops   Style 103	
6361-103	SPRUCE 6'H   Spaced	Spruce Backrails   Cedar   #2 and #4 Picket Tops   Style 103	

### CEDAR BACKRAILS

Item #	Backrails	Description	Each
3371-103	CEDAR 3'H   Spaced	Cedar Backrails   Cedar   #2 and #4 Picket Tops   Style 103	
4371-103	CEDAR 4'H   Spaced	Cedar Backrails   Cedar   #2 and #4 Picket Tops   Style 103	
5371-103	CEDAR 5'H   Spaced	Cedar Backrails   Cedar   #2 and #4 Picket Tops   Style 103	
6371-103	CEDAR 6'H   Spaced	Cedar Backrails   Cedar   #2 and #4 Picket Tops   Style 103	

**MATCHING GATES AVAILABLE**

**PLEASE NOTE: ONCE DELIVERED, EASTERN WOOD FENCE IS NON-REFUNDABLE.**

Wood fence is a natural product and natural weathering including splitting, warping, twisting, checking, raised grain, swelling, shrinkage, surface mold and/or mildew, fungi, or any other physical property of the wood including but not limited to knots can occur.

# SPACED PICKET - 350

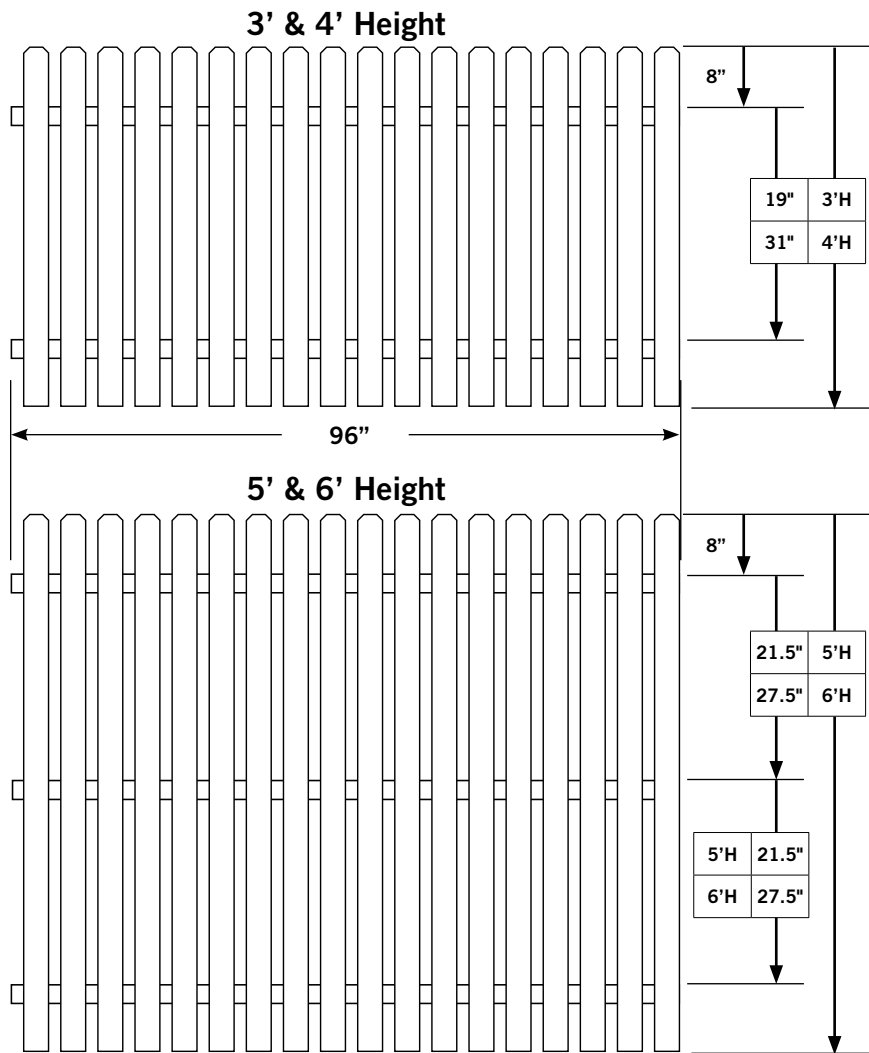

## 350 STYLE SPACED PICKET

3', 4', 5', 6' Height #1 Cedar Spaced Picket Fence with #5 Picket Tops

BOARDS	Nominal 1" x 4" / 18 Per Section
SPACING	Nominal 1-3/4" to 1-7/8"
SPECIES	White Cedar
NAILING	Double Nailed
NAILS	Aluminum Spiral Nails
WIDTH	96" Exact
RAILS	STANDARD: 2" x 3" Nominal Cedar OPTIONAL: 2" x 3" Nominal Spruce OPTIONAL: Dowelled backrails - (Measurements may deviate from standard. Call for pricing and info)
TABS	STANDARD: Left side (See diagram ←) OPTIONAL: No tabs (ADD \$) OPTIONAL: Right side (ADD \$) OPTIONAL: Both sides (ADD \$)
GATES	Matching gates available. Please CALL for more information

### PICKET TOP STYLES

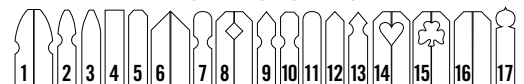

## SPRUCE BACKRAILS

Item #	Backrails	Description						Each
3361-350	SPRUCE 3'H   Spaced	Spruce Backrails	Cedar	#5 Picket Tops	Style 350			
4361-350	SPRUCE 4'H   Spaced	Spruce Backrails	Cedar	#5 Picket Tops	Style 350			
5361-350	SPRUCE 5'H   Spaced	Spruce Backrails	Cedar	#5 Picket Tops	Style 350			
6361-350	SPRUCE 6'H   Spaced	Spruce Backrails	Cedar	#5 Picket Tops	Style 350			

## CEDAR BACKRAILS

Item #	Backrails	Description						Each
3371-350	CEDAR 3'H   Spaced	Cedar Backrails	Cedar	#5 Picket Tops	Style 350			
4371-350	CEDAR 4'H   Spaced	Cedar Backrails	Cedar	#5 Picket Tops	Style 350			
5371-350	CEDAR 5'H   Spaced	Cedar Backrails	Cedar	#5 Picket Tops	Style 350			
6371-350	CEDAR 6'H   Spaced	Cedar Backrails	Cedar	#5 Picket Tops	Style 350			

**MATCHING GATES AVAILABLE**

**PLEASE NOTE: ONCE DELIVERED, EASTERN WOOD FENCE IS NON-REFUNDABLE.**

Wood fence is a natural product and natural weathering including splitting, warping, twisting, checking, raised grain, swelling, shrinkage, surface mold and/or mildew, fungi, or any other physical property of the wood including but not limited to knots can occur.

# SPACED PICKET - 352

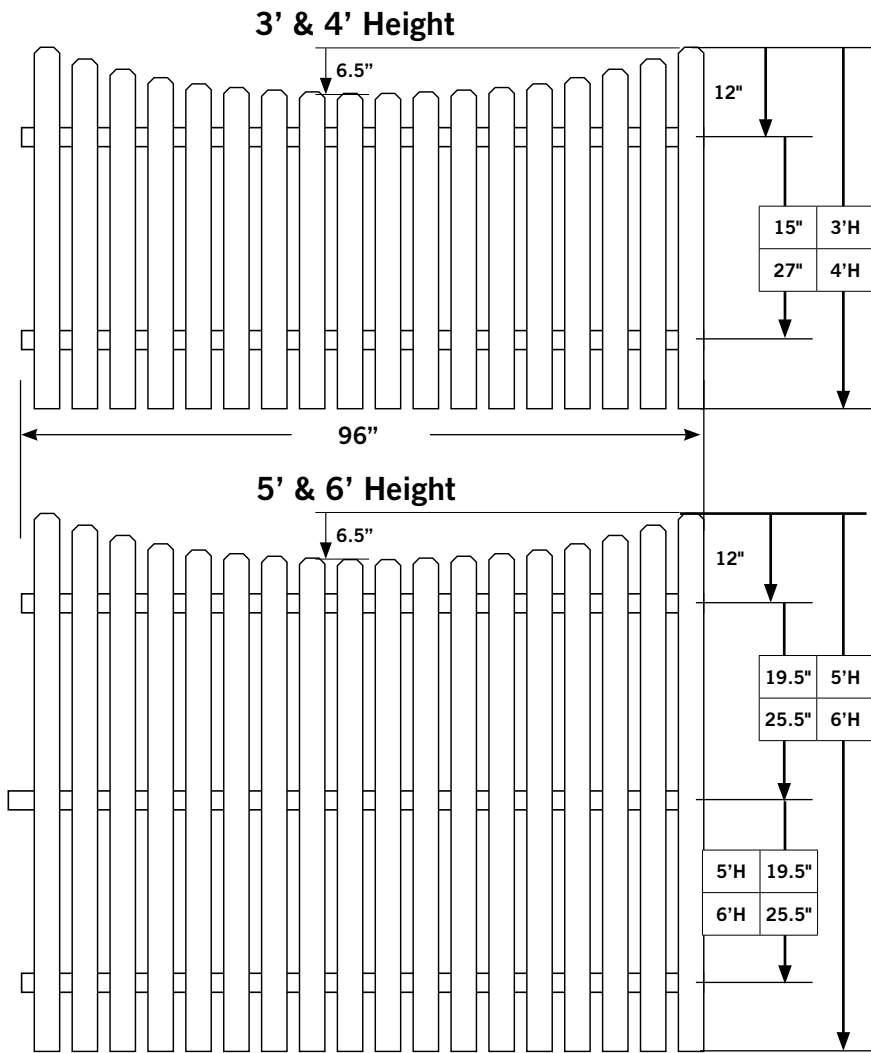

## 352 STYLE SPACED PICKET

3', 4', 5', 6' Height #1 Cedar Spaced Picket Fence with #5 Picket Tops

BOARDS	Nominal 1" x 4" / 18 Per Section
SPACING	Nominal 1-3/4" to 1-7/8"
SPECIES	White Cedar
NAILING	Double Nailed
NAILS	Aluminum Spiral Nails
WIDTH	96" Exact
RAILS	STANDARD: 2" x 3" Nominal Cedar OPTIONAL: 2" x 3" Nominal Spruce OPTIONAL: Dowelled backrails - (Measurements may deviate from standard. Call for pricing and info)
TABS	STANDARD: Left side (See diagram ←) OPTIONAL: No tabs OPTIONAL: Right side OPTIONAL: Both sides
GATES	Matching gates available. Please CALL for more information

### PICKET TOP STYLES

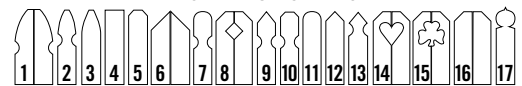

## SPRUCE BACKRAILS

Item #	Backrails	Description	Each
3361-352	SPRUCE 3'H   Spaced	Spruce Backrails   Cedar   #5 Picket Tops   Style 352	
4361-352	SPRUCE 4'H   Spaced	Spruce Backrails   Cedar   #5 Picket Tops   Style 352	
5361-352	SPRUCE 5'H   Spaced	Spruce Backrails   Cedar   #5 Picket Tops   Style 352	
6361-352	SPRUCE 6'H   Spaced	Spruce Backrails   Cedar   #5 Picket Tops   Style 352	

## CEDAR BACKRAILS

Item #	Backrails	Description	Each
3371-352	CEDAR 3'H   Spaced	Cedar Backrails   Cedar   #5 Picket Tops   Style 352	
4371-352	CEDAR 4'H   Spaced	Cedar Backrails   Cedar   #5 Picket Tops   Style 352	
5371-352	CEDAR 5'H   Spaced	Cedar Backrails   Cedar   #5 Picket Tops   Style 352	
6371-352	CEDAR 6'H   Spaced	Cedar Backrails   Cedar   #5 Picket Tops   Style 352	

**MATCHING GATES AVAILABLE**

**PLEASE NOTE: ONCE DELIVERED, EASTERN WOOD FENCE IS NON-REFUNDABLE.**

Wood fence is a natural product and natural weathering including splitting, warping, twisting, checking, raised grain, swelling, shrinkage, surface mold and/or mildew, fungi, or any other physical property of the wood including but not limited to knots can occur.

# SPACED PICKET - 401

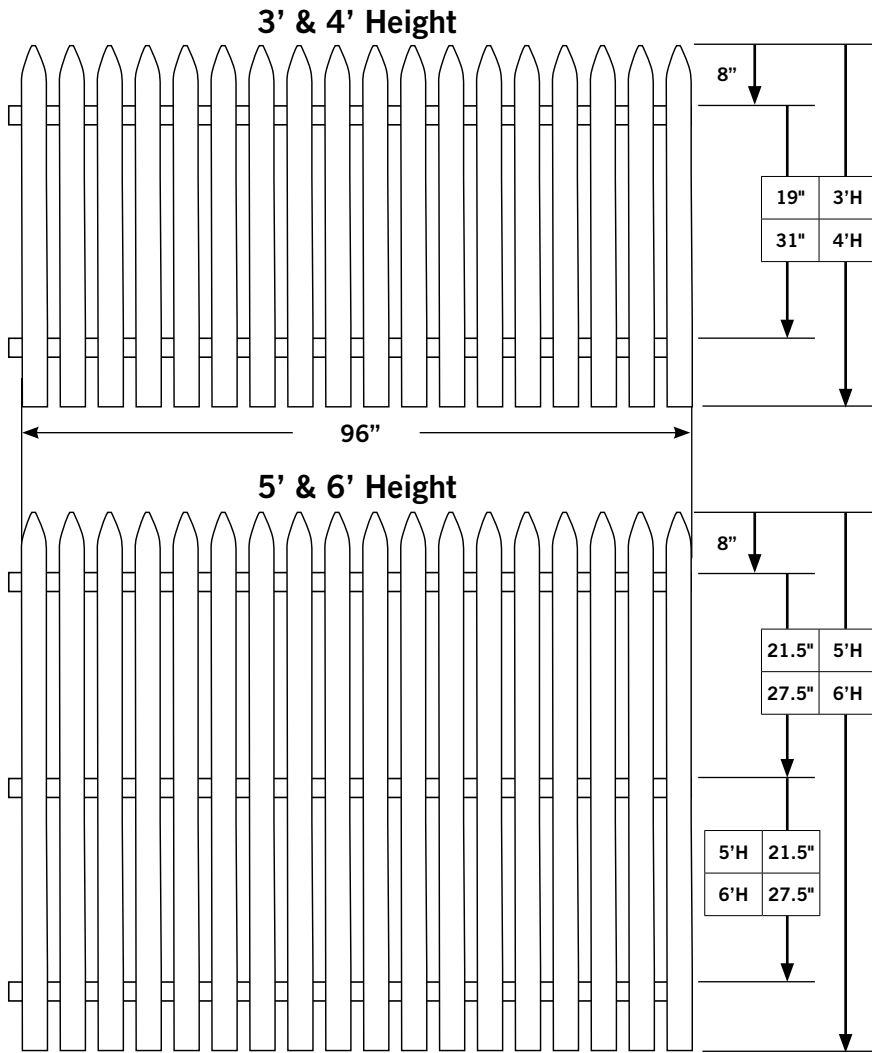

## 401 STYLE SPACED PICKET 3', 4', 5', 6' Height #1 Cedar Spaced Picket Fence with #3 Picket Tops

BOARDS	Nominal 1" x 4" / 18 Per Section
SPACING	Nominal 1-3/4" to 1-7/8"
SPECIES	White Cedar
NAILING	Double Nailed
NAILS	Aluminum Spiral Nails
WIDTH	96" Exact
RAILS	STANDARD: 2" x 3" Nominal Cedar OPTIONAL: 2" x 3" Nominal Spruce OPTIONAL: Dowelled backrails - (Measurements may deviate from standard. Call for pricing and info)
TABS	STANDARD: Left side (See diagram ←) OPTIONAL: No tabs (4371-401* ADD \$) OPTIONAL: Right side (4371-401* ADD \$) OPTIONAL: Both sides (4371-401* ADD \$)
GATES	Matching gates available. Please CALL for more information

### PICKET TOP STYLES

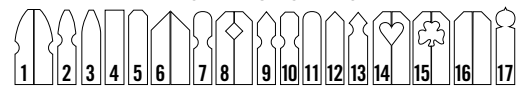

## SPRUCE BACKRAILS

Item #	Backrails	Description						Each
3361-401	SPRUCE 3'H	Spaced	Spruce Backrails	Cedar	#3 Picket Tops	Style 401		
4361-401	SPRUCE 4'H	Spaced	Spruce Backrails	Cedar	#3 Picket Tops	Style 401		
5361-401	SPRUCE 5'H	Spaced	Spruce Backrails	Cedar	#3 Picket Tops	Style 401		
6361-401	SPRUCE 6'H	Spaced	Spruce Backrails	Cedar	#3 Picket Tops	Style 401		

## CEDAR BACKRAILS

Item #	Backrails	Description						Each
3371-401	CEDAR 3'H	Spaced	Cedar Backrails	Cedar	#3 Picket Tops	Style 401		
4371-401*	CEDAR 4'H	Spaced	Cedar Backrails	Cedar	#3 Picket Tops	Style 401		
5371-401	CEDAR 5'H	Spaced	Cedar Backrails	Cedar	#3 Picket Tops	Style 401		
6371-401	CEDAR 6'H	Spaced	Cedar Backrails	Cedar	#3 Picket Tops	Style 401		

**MATCHING  
GATES  
AVAILABLE**

**PLEASE NOTE: ONCE DELIVERED, EASTERN WOOD FENCE IS NON-REFUNDABLE.**

Wood fence is a natural product and natural weathering including splitting, warping, twisting, checking, raised grain, swelling, shrinkage, surface mold and/or mildew, fungi, or any other physical property of the wood including but not limited to knots can occur.

# SPACED PICKET - 402

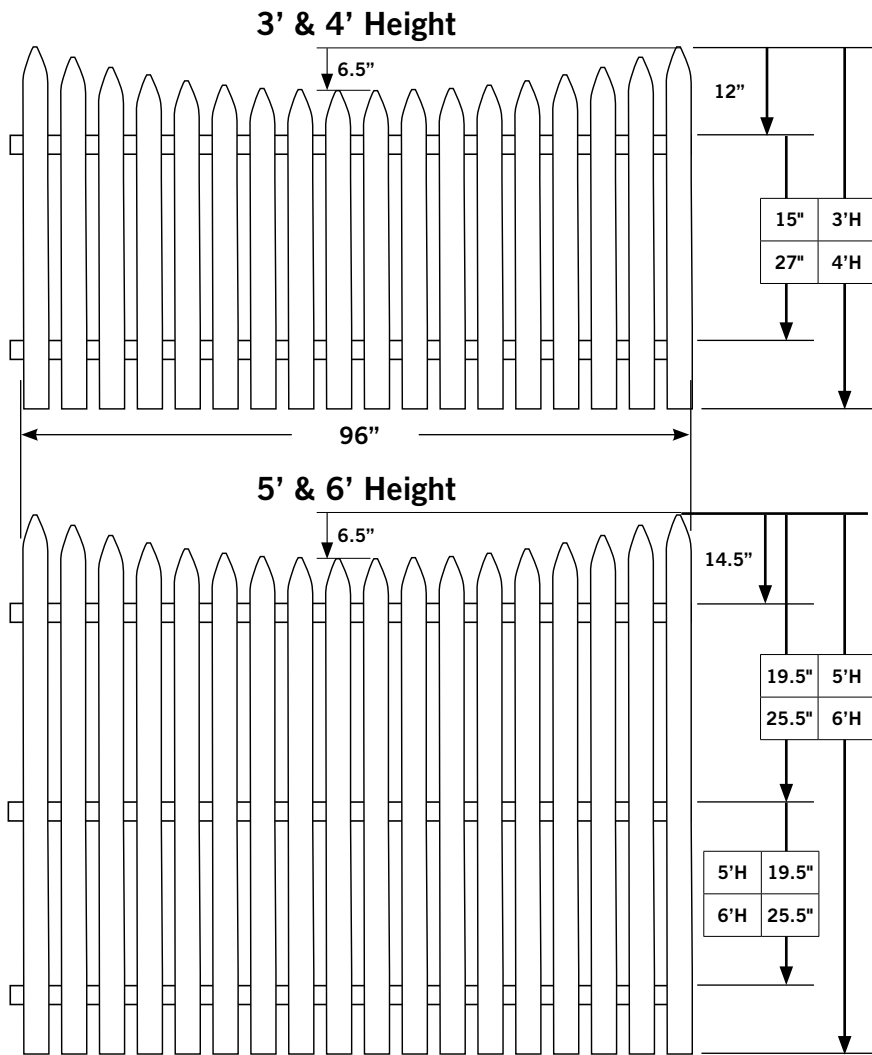

## 402 STYLE SPACED PICKET 3', 4', 5', 6' Height #1 Cedar Spaced Picket Fence with #3 Picket Tops

BOARDS	Nominal 1" x 4" / 18 Per Section
SPACING	Nominal 1-3/4" to 1-7/8"
SPECIES	White Cedar
NAILING	Double Nailed
NAILS	Aluminum Spiral Nails
WIDTH	96" Exact
RAILS	STANDARD: 2" x 3" Nominal Cedar OPTIONAL: 2" x 3" Nominal Spruce OPTIONAL: Dowelled backrails - (Measurements may deviate from standard. Call for pricing and info)
TABS	STANDARD: Left side (See diagram ←) OPTIONAL: No tabs OPTIONAL: Right side OPTIONAL: Both sides
GATES	Matching gates available. Please CALL for more information

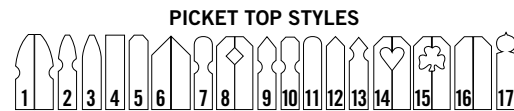

### SPRUCE BACKRAILS

Item #	Backrails	Description						Each
3361-402	SPRUCE 3'H   Spaced	Spruce Backrails	Cedar	#3 Picket Tops	Style 402			
4361-402	SPRUCE 4'H   Spaced	Spruce Backrails	Cedar	#3 Picket Tops	Style 402			
5361-402	SPRUCE 5'H   Spaced	Spruce Backrails	Cedar	#3 Picket Tops	Style 402			
6361-402	SPRUCE 6'H   Spaced	Spruce Backrails	Cedar	#3 Picket Tops	Style 402			

### CEDAR BACKRAILS

Item #	Backrails	Description						Each
3371-402	CEDAR 3'H   Spaced	Cedar Backrails	Cedar	#3 Picket Tops	Style 402			
4371-402	CEDAR 4'H   Spaced	Cedar Backrails	Cedar	#3 Picket Tops	Style 402			
5371-402	CEDAR 5'H   Spaced	Cedar Backrails	Cedar	#3 Picket Tops	Style 402			
6371-402	CEDAR 6'H   Spaced	Cedar Backrails	Cedar	#3 Picket Tops	Style 402			

**MATCHING GATES AVAILABLE**

**PLEASE NOTE: ONCE DELIVERED, EASTERN WOOD FENCE IS NON-REFUNDABLE.**

Wood fence is a natural product and natural weathering including splitting, warping, twisting, checking, raised grain, swelling, shrinkage, surface mold and/or mildew, fungi, or any other physical property of the wood including but not limited to knots can occur.

# SPACED PICKET - 110

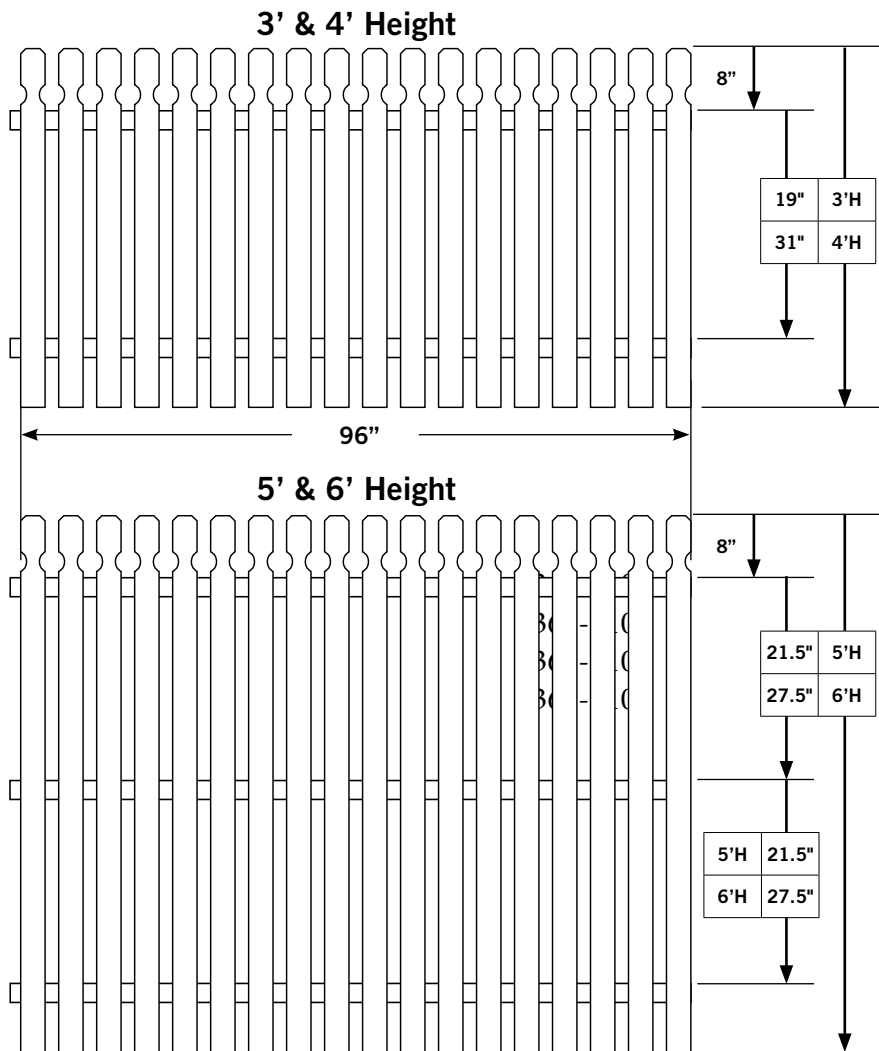

## 110 STYLE SPACED PICKET

3', 4', 5', 6' Height #1 Cedar Spaced Picket Fence with #10 Picket Tops

BOARDS	Nominal 1" x 4" / 18 Per Section
SPACING	Nominal 1-3/4" to 1-7/8"
SPECIES	White Cedar
NAILING	Double Nailed
NAILS	Aluminum Spiral Nails
WIDTH	96" Exact
RAILS	STANDARD: 2" x 3" Nominal Cedar OPTIONAL: 2" x 3" Nominal Spruce OPTIONAL: Dowelled backrails - (Measurements may deviate from standard. Call for pricing and info)
TABS	STANDARD: Left side (See diagram ←) OPTIONAL: No tabs OPTIONAL: Right side OPTIONAL: Both sides
GATES	Matching gates available. Please CALL for more information

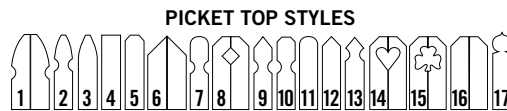

### SPRUCE BACKRAILS

Item #	Backrails	Description						Each
3361-110	SPRUCE 3'H	Spaced	Spruce Backrails	Cedar	#10 Picket Tops	Style 110		
4361-110	SPRUCE 4'H	Spaced	Spruce Backrails	Cedar	#10 Picket Tops	Style 110		
5361-110	SPRUCE 5'H	Spaced	Spruce Backrails	Cedar	#10 Picket Tops	Style 110		
6361-110	SPRUCE 6'H	Spaced	Spruce Backrails	Cedar	#10 Picket Tops	Style 110		

### CEDAR BACKRAILS

Item #	Backrails	Description						Each
3371-110	CEDAR 3'H	Spaced	Cedar Backrails	Cedar	#10 Picket Tops	Style 110		
4371-110	CEDAR 4'H	Spaced	Cedar Backrails	Cedar	#10 Picket Tops	Style 110		
5371-110	CEDAR 5'H	Spaced	Cedar Backrails	Cedar	#10 Picket Tops	Style 110		
6371-110	CEDAR 6'H	Spaced	Cedar Backrails	Cedar	#10 Picket Tops	Style 110		

**MATCHING GATES AVAILABLE**

**PLEASE NOTE: ONCE DELIVERED, EASTERN WOOD FENCE IS NON-REFUNDABLE.**

Wood fence is a natural product and natural weathering including splitting, warping, twisting, checking, raised grain, swelling, shrinkage, surface mold and/or mildew, fungi, or any other physical property of the wood including but not limited to knots can occur.

# SPACED PICKET - 111

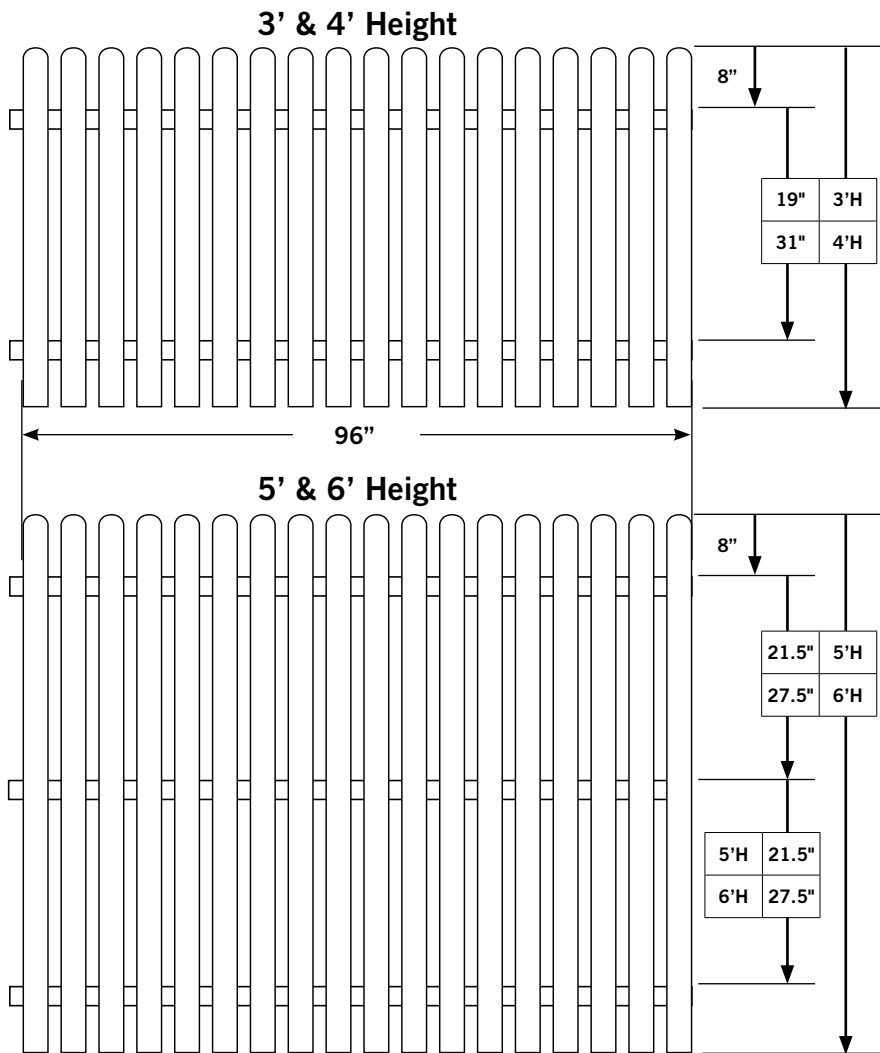

## 111 STYLE SPACED PICKET

3', 4', 5', 6' Height #1 Cedar Spaced Picket Fence with #11 Picket Tops

BOARDS	Nominal 1" x 4" / 18 Per Section
SPACING	Nominal 1-3/4" to 1-7/8"
SPECIES	White Cedar
NAILING	Double Nailed
NAILS	Aluminum Spiral Nails
WIDTH	96" Exact
RAILS	STANDARD: 2" x 3" Nominal Cedar OPTIONAL: 2" x 3" Nominal Spruce OPTIONAL: Dowelled backrails - (Measurements may deviate from standard. Call for pricing and info)
TABS	STANDARD: Left side (See diagram ←) OPTIONAL: No tabs OPTIONAL: Right side OPTIONAL: Both sides
GATES	Matching gates available. Please CALL for more information

### PICKET TOP STYLES

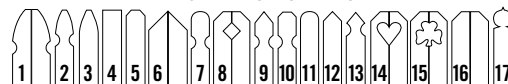

## SPRUCE BACKRAILS

Item #	Backrails	Description						Each
3361-111	SPRUCE 3'H	Spaced	Spruce Backrails	Cedar	#11 Picket Tops	Style 111		
4361-111	SPRUCE 4'H	Spaced	Spruce Backrails	Cedar	#11 Picket Tops	Style 111		
5361-111	SPRUCE 5'H	Spaced	Spruce Backrails	Cedar	#11 Picket Tops	Style 111		
6361-111	SPRUCE 6'H	Spaced	Spruce Backrails	Cedar	#11 Picket Tops	Style 111		

## CEDAR BACKRAILS

Item #	Backrails	Description						Each
3371-111	CEDAR 3'H	Spaced	Cedar Backrails	Cedar	#11 Picket Tops	Style 111		
4371-111	CEDAR 4'H	Spaced	Cedar Backrails	Cedar	#11 Picket Tops	Style 111		
5371-111	CEDAR 5'H	Spaced	Cedar Backrails	Cedar	#11 Picket Tops	Style 111		
6371-111	CEDAR 6'H	Spaced	Cedar Backrails	Cedar	#11 Picket Tops	Style 111		

**MATCHING GATES AVAILABLE**

**PLEASE NOTE: ONCE DELIVERED, EASTERN WOOD FENCE IS NON-REFUNDABLE.**

Wood fence is a natural product and natural weathering including splitting, warping, twisting, checking, raised grain, swelling, shrinkage, surface mold and/or mildew, fungi, or any other physical property of the wood including but not limited to knots can occur.

# SPACED PICKET - 112

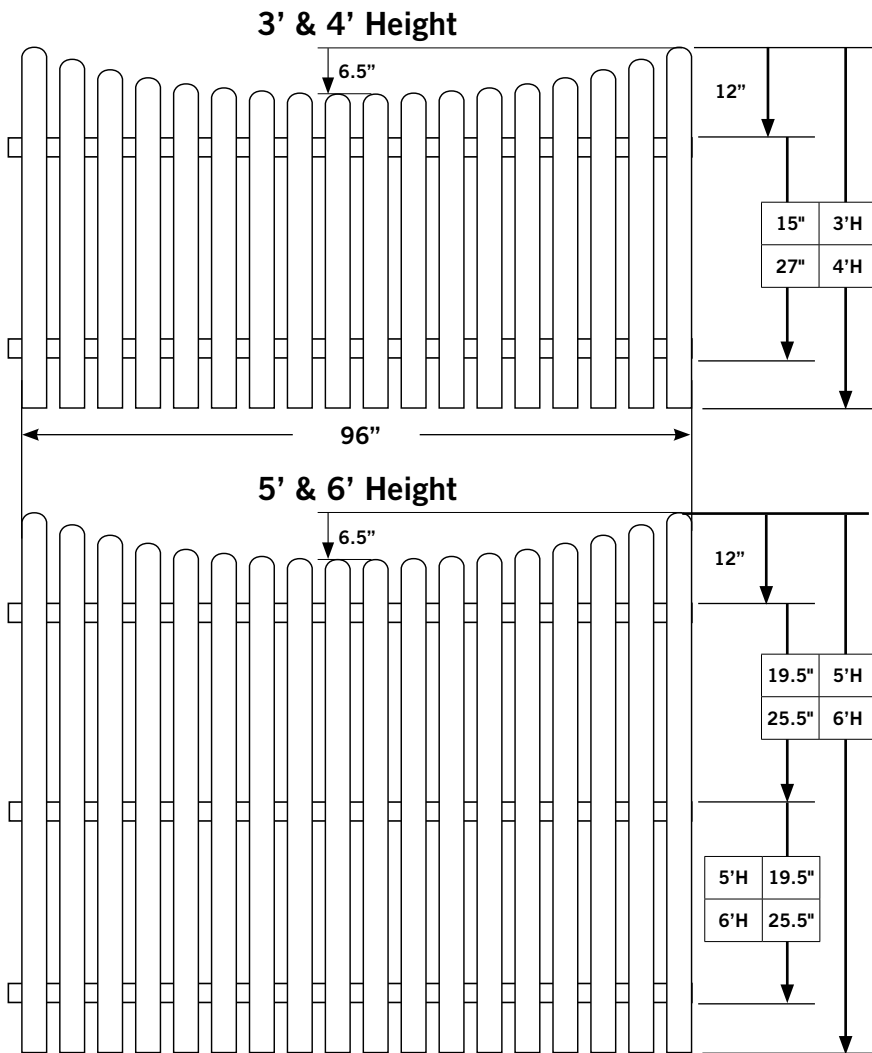

## 112 STYLE SPACED PICKET

3', 4', 5', 6' Height #1 Cedar Spaced Picket Fence with #11 Picket Tops

BOARDS	Nominal 1" x 4" / 18 Per Section
SPACING	Nominal 1-3/4" to 1-7/8"
SPECIES	White Cedar
NAILING	Double Nailed
NAILS	Aluminum Spiral Nails
WIDTH	96" Exact
RAILS	STANDARD: 2" x 3" Nominal Cedar OPTIONAL: 2" x 3" Nominal Spruce OPTIONAL: Dowelled backrails - (Measurements may deviate from standard. Call for pricing and info)
TABS	STANDARD: Left side (See diagram ←) OPTIONAL: No tabs OPTIONAL: Right side OPTIONAL: Both sides
GATES	Matching gates available. Please CALL for more information

### PICKET TOP STYLES

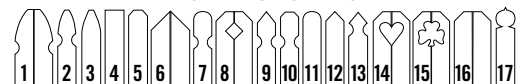

## SPRUCE BACKRAILS

Item #	Backrails	Description						Each
3361-112	SPRUCE 3'H   Spaced	Spruce Backrails	Cedar	#11 Picket Tops	Style 112			
4361-112	SPRUCE 4'H   Spaced	Spruce Backrails	Cedar	#11 Picket Tops	Style 112			
5361-112	SPRUCE 5'H   Spaced	Spruce Backrails	Cedar	#11 Picket Tops	Style 112			
6361-112	SPRUCE 6'H   Spaced	Spruce Backrails	Cedar	#11 Picket Tops	Style 112			

## CEDAR BACKRAILS

Item #	Backrails	Description						Each
3371-112	CEDAR 3'H   Spaced	Cedar Backrails	Cedar	#11 Picket Tops	Style 112			
4371-112	CEDAR 4'H   Spaced	Cedar Backrails	Cedar	#11 Picket Tops	Style 112			
5371-112	CEDAR 5'H   Spaced	Cedar Backrails	Cedar	#11 Picket Tops	Style 112			
6371-112	CEDAR 6'H   Spaced	Cedar Backrails	Cedar	#11 Picket Tops	Style 112			

**MATCHING GATES AVAILABLE**

**PLEASE NOTE: ONCE DELIVERED, EASTERN WOOD FENCE IS NON-REFUNDABLE.**

Wood fence is a natural product and natural weathering including splitting, warping, twisting, checking, raised grain, swelling, shrinkage, surface mold and/or mildew, fungi, or any other physical property of the wood including but not limited to knots can occur.

# SOLID PANELS - POPULAR STYLES



## WHITE CEDAR SOLID PANELS

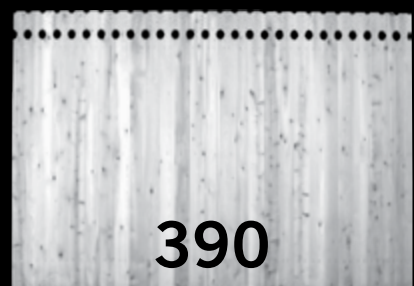
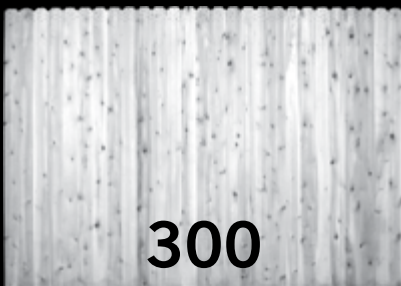

# SOLID PANELS - 111



3' & 4' Height

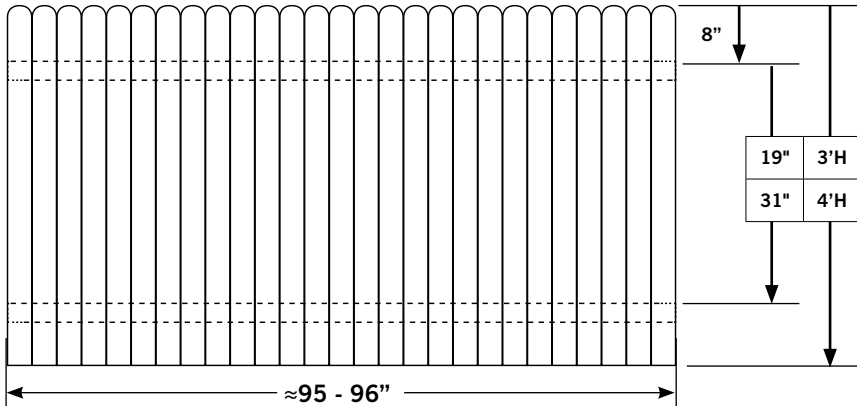

5' & 6' Height

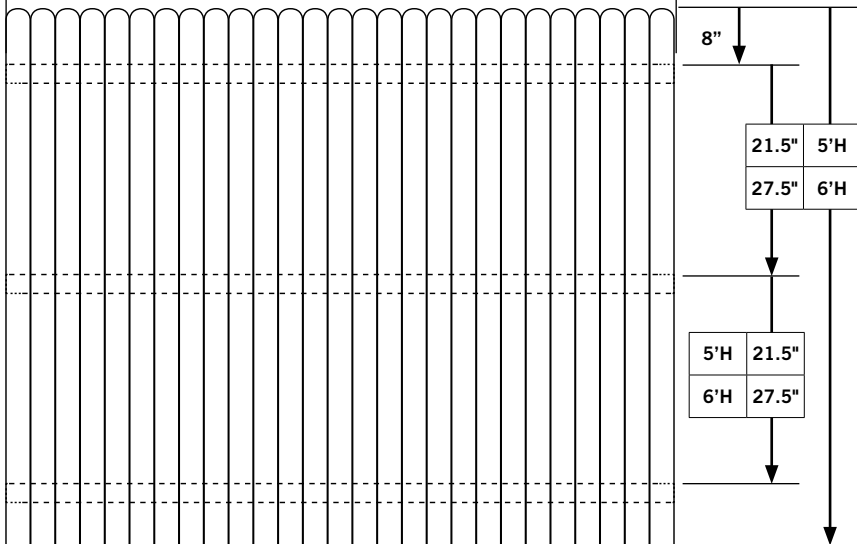

## 111 STYLE SOLID PANEL

3', 4', 5', 6' Height Cedar Solid Panels with #11 Style Picket Tops

BOARDS	Nominal 1" x 4" / 27 Per Section
SPECIES	White Cedar
NAILING	TOP AND BOTTOM RAILS: Double Nailed MID-RAIL: End pickets are doubled nailed and the inside pickets are single nailed
NAILS	Aluminum Spiral Nails
WIDTH	96" Nominal (Approx. 95" - 96")
RAILS	STANDARD: 2" x 3" Nominal Cedar OPTIONAL: 2" x 3" Nominal Spruce OPTIONAL: Dowelled backrails - (Measurements may deviate from standard. Call for pricing and info)
GATES	Matching gates available. Please CALL for more information

### PICKET TOP STYLES

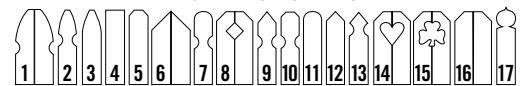

## SPRUCE BACKRAILS

Item #	Backrails	Description						Each
3462-111	SPRUCE 3'H   Solid	Spruce Backrails	Cedar Boards	#11 Style Picket Tops	Style 111			
4462-111	SPRUCE 4'H   Solid	Spruce Backrails	Cedar Boards	#11 Style Picket Tops	Style 111			
5462-111	SPRUCE 5'H   Solid	Spruce Backrails	Cedar Boards	#11 Style Picket Tops	Style 111			
6462-111	SPRUCE 6'H   Solid	Spruce Backrails	Cedar Boards	#11 Style Picket Tops	Style 111			
8462-111	SPRUCE 8'H   Solid	Spruce rails	Cedar Boards	#11 Style Picket Tops	Style 111			

## CEDAR BACKRAILS

Item #	Backrails	Description						Each
3472-111	CEDAR 3'H   Solid	Cedar Backrails	Cedar Boards	#11 Style Picket Tops	Style 111			
4472-111	CEDAR 4'H   Solid	Cedar Backrails	Cedar Boards	#11 Style Picket Tops	Style 111			
5472-111	CEDAR 5'H   Solid	Cedar Backrails	Cedar Boards	#11 Style Picket Tops	Style 111			
6472-111	CEDAR 6'H   Solid	Cedar Backrails	Cedar Boards	#11 Style Picket Tops	Style 111			
8472-111	CEDAR 8'H   Solid	Cedar Backrails	Cedar Boards	#11 Style Picket Tops	Style 111			

**MATCHING GATES AVAILABLE**

**PLEASE NOTE: ONCE DELIVERED, EASTERN WOOD FENCE IS NON-REFUNDABLE.**

Wood fence is a natural product and natural weathering including splitting, warping, twisting, checking, raised grain, swelling, shrinkage, surface mold and/or mildew, fungi, or any other physical property of the wood including but not limited to knots can occur.

# SOLID PANELS - 120



3' & 4' Height

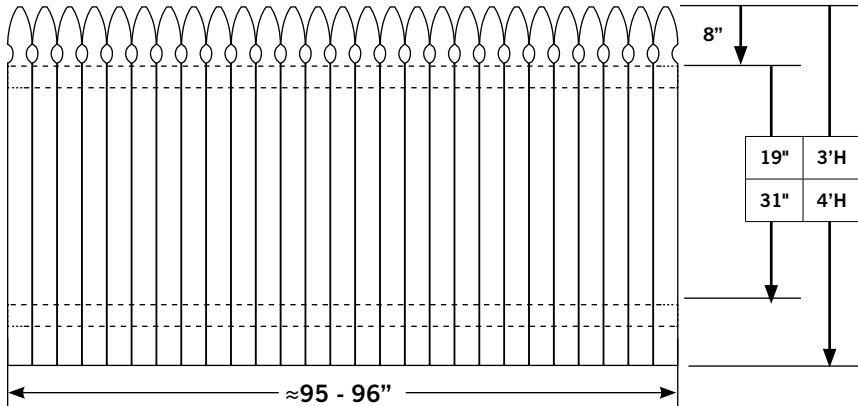

5' & 6' Height

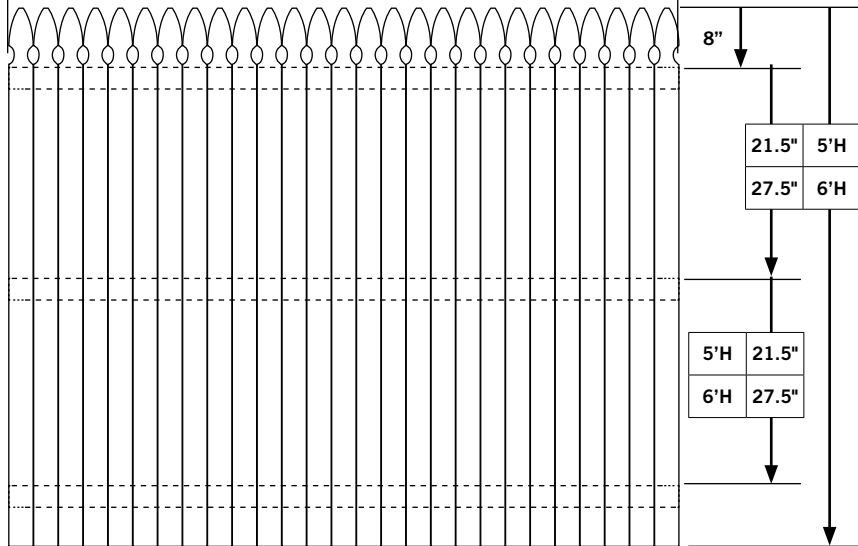

## 120 STYLE SOLID PANEL

3', 4', 5', 6' Height Cedar Solid Panels with #2 Style Picket Tops

- BOARDS Nominal 1" x 4" / 27 Per Section
- SPECIES White Cedar
- NAILING TOP AND BOTTOM RAILS: Double Nailed  
MID-RAIL: End pickets are doubled nailed and the inside pickets are single nailed
- NAILS Aluminum Spiral Nails
- WIDTH 96" Nominal (Approx. 95" - 96")
- RAILS STANDARD: 2" x 3" Nominal Cedar  
OPTIONAL: 2" x 3" Nominal Spruce  
OPTIONAL: Dowelled backrails - (Measurements may deviate from standard. Call for pricing and info)
- GATES Matching gates available. Please CALL for more information

### PICKET TOP STYLES

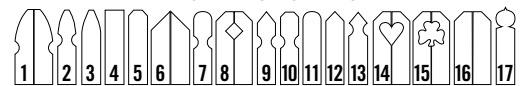

## SPRUCE BACKRAILS

Item #	Backrails	Description						Each
3462-120	SPRUCE 3'H	Solid	Spruce Backrails	Cedar Boards	#2 Style Picket Tops	Style 120		
4462-120	SPRUCE 4'H	Solid	Spruce Backrails	Cedar Boards	#2 Style Picket Tops	Style 120		
5462-120	SPRUCE 5'H	Solid	Spruce Backrails	Cedar Boards	#2 Style Picket Tops	Style 120		
6462-120	SPRUCE 6'H	Solid	Spruce Backrails	Cedar Boards	#2 Style Picket Tops	Style 120		
8462-120	SPRUCE 8'H	Solid	Spruce Backrails	Cedar Boards	#2 Style Picket Tops	Style 120		

## CEDAR BACKRAILS

Item #	Backrails	Description						Each
3472-120	CEDAR 3'H	Solid	Cedar Backrails	Cedar Boards	#2 Style Picket Tops	Style 120		
4472-120	CEDAR 4'H	Solid	Cedar Backrails	Cedar Boards	#2 Style Picket Tops	Style 120		
5472-120	CEDAR 5'H	Solid	Cedar Backrails	Cedar Boards	#2 Style Picket Tops	Style 120		
6472-120	CEDAR 6'H	Solid	Cedar Backrails	Cedar Boards	#2 Style Picket Tops	Style 120		
8472-120	CEDAR 8'H	Solid	Cedar Backrails	Cedar Boards	#2 Style Picket Tops	Style 120		

**MATCHING GATES AVAILABLE**

**PLEASE NOTE: ONCE DELIVERED, EASTERN WOOD FENCE IS NON-REFUNDABLE.**

Wood fence is a natural product and natural weathering including splitting, warping, twisting, checking, raised grain, swelling, shrinkage, surface mold and/or mildew, fungi, or any other physical property of the wood including but not limited to knots can occur.

# SOLID PANELS - 121

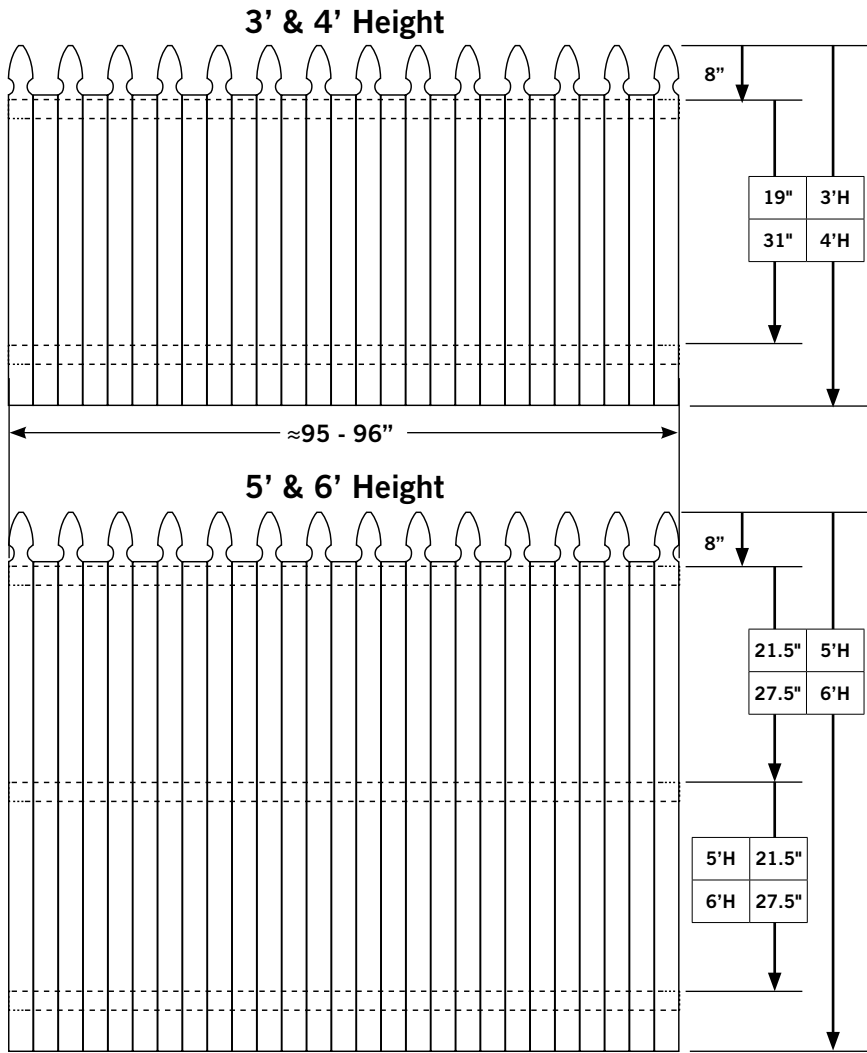

## 121 STYLE SOLID PANEL

3', 4', 5', 6' Height Cedar Solid Panels with #2 and #4 Style Picket Tops

BOARDS	Nominal 1" x 4" / 27 Per Section
SPECIES	White Cedar
NAILING	TOP AND BOTTOM RAILS: Double Nailed MID-RAIL: End pickets are doubled nailed and the inside pickets are single nailed
NAILS	Aluminum Spiral Nails
WIDTH	96" Nominal (Approx. 95" - 96")
RAILS	STANDARD: 2" x 3" Nominal Cedar OPTIONAL: 2" x 3" Nominal Spruce OPTIONAL: Dowelled backrails - (Measurements may deviate from standard. Call for pricing and info)
GATES	Matching gates available. Please CALL for more information

### PICKET TOP STYLES

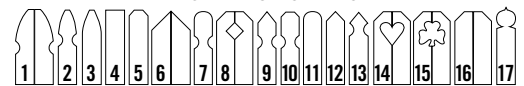

## SPRUCE BACKRAILS

Item #	Backrails	Description						Each
3462-121	SPRUCE 3'H	Solid	Spruce Backrails	Cedar Boards	#2 and #4 Style Picket Tops	Style 121		
4462-121	SPRUCE 4'H	Solid	Spruce Backrails	Cedar Boards	#2 and #4 Style Picket Tops	Style 121		
5462-121	SPRUCE 5'H	Solid	Spruce Backrails	Cedar Boards	#2 and #4 Style Picket Tops	Style 121		
6462-121	SPRUCE 6'H	Solid	Spruce Backrails	Cedar Boards	#2 and #4 Style Picket Tops	Style 121		
8462-121	SPRUCE 8'H	Solid	Spruce Backrails	Cedar Boards	#2 and #4 Style Picket Tops	Style 121		

## CEDAR BACKRAILS

Item #	Backrails	Description						Each
3472-121	CEDAR 3'H	Solid	Cedar Backrails	Cedar Boards	#2 and #4 Style Picket Tops	Style 121		
4472-121	CEDAR 4'H	Solid	Cedar Backrails	Cedar Boards	#2 and #4 Style Picket Tops	Style 121		
5472-121	CEDAR 5'H	Solid	Cedar Backrails	Cedar Boards	#2 and #4 Style Picket Tops	Style 121		
6472-121	CEDAR 6'H	Solid	Cedar Backrails	Cedar Boards	#2 and #4 Style Picket Tops	Style 121		
8472-121	CEDAR 8'H	Solid	Cedar Backrails	Cedar Boards	#2 and #4 Style Picket Tops	Style 121		

**MATCHING GATES AVAILABLE**

**PLEASE NOTE: ONCE DELIVERED, EASTERN WOOD FENCE IS NON-REFUNDABLE.**

Wood fence is a natural product and natural weathering including splitting, warping, twisting, checking, raised grain, swelling, shrinkage, surface mold and/or mildew, fungi, or any other physical property of the wood including but not limited to knots can occur.

# SOLID PANELS - 200



## 3' & 4' Height

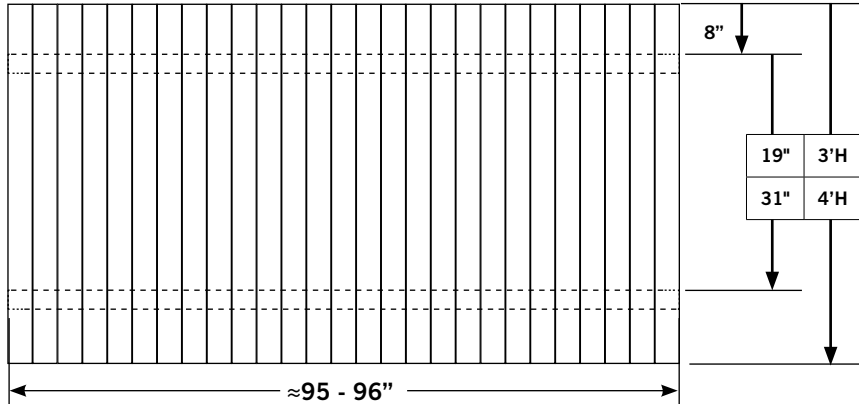

## 5' & 6' Height

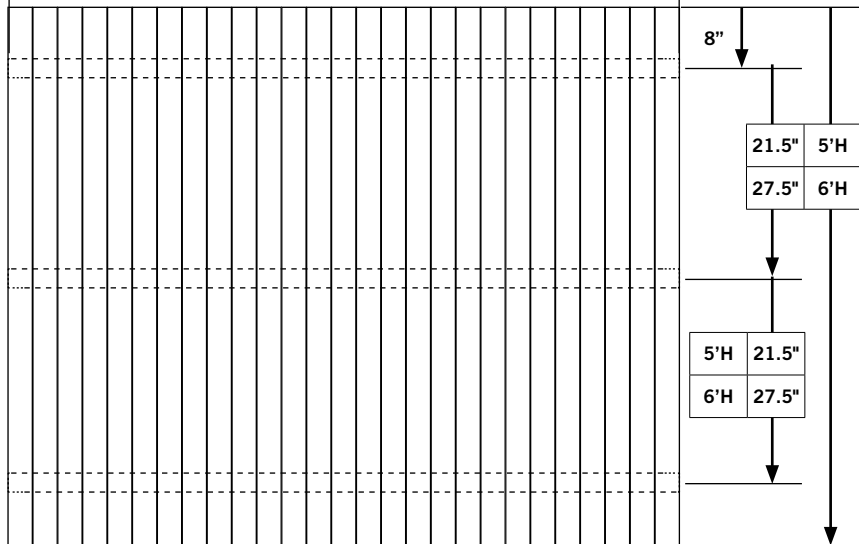

## 200 STYLE SOLID PANEL

3', 4', 5', 6' Height Cedar Solid Panels with #4 Style Picket Tops

- BOARDS Nominal 1" x 4" / 27 Per Section
- SPECIES White Cedar
- NAILING TOP AND BOTTOM RAILS: Double Nailed  
MID-RAIL: End pickets are doubled nailed and the inside pickets are single nailed
- NAILS Aluminum Spiral Nails
- WIDTH 96" Nominal (Approx. 95" - 96")
- RAILS STANDARD: 2" x 3" Nominal Cedar  
OPTIONAL: 2" x 3" Nominal Spruce  
OPTIONAL: Dowelled backrails - (Measurements may deviate from standard. Call for pricing and info)
- GATES Matching gates available. Please CALL for more information

### PICKET TOP STYLES

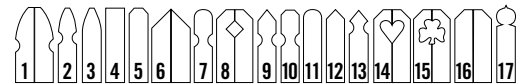

## SPRUCE BACKRAILS

Item #	Backrails	Description						Each
3462-200	SPRUCE 3'H	Solid	Spruce Backrails	Cedar Boards	#4 Style Picket Tops	Style 200		
4462-200	SPRUCE 4'H	Solid	Spruce Backrails	Cedar Boards	#4 Style Picket Tops	Style 200		
5462-200	SPRUCE 5'H	Solid	Spruce Backrails	Cedar Boards	#4 Style Picket Tops	Style 200		
6462-200	SPRUCE 6'H	Solid	Spruce Backrails	Cedar Boards	#4 Style Picket Tops	Style 200		
8462-200	SPRUCE 8'H	Solid	Spruce Backrails	Cedar Boards	#4 Style Picket Tops	Style 200		

## CEDAR BACKRAILS

Item #	Backrails	Description						Each
3472-200	CEDAR 3'H	Solid	Cedar Backrails	Cedar Boards	#4 Style Picket Tops	Style 200		
4472-200	CEDAR 4'H	Solid	Cedar Backrails	Cedar Boards	#4 Style Picket Tops	Style 200		
5472-200	CEDAR 5'H	Solid	Cedar Backrails	Cedar Boards	#4 Style Picket Tops	Style 200		
6472-200	CEDAR 6'H	Solid	Cedar Backrails	Cedar Boards	#4 Style Picket Tops	Style 200		
8472-200	CEDAR 8'H	Solid	Cedar Backrails	Cedar Boards	#4 Style Picket Tops	Style 200		

**MATCHING GATES AVAILABLE**

**PLEASE NOTE: ONCE DELIVERED, EASTERN WOOD FENCE IS NON-REFUNDABLE.**

Wood fence is a natural product and natural weathering including splitting, warping, twisting, checking, raised grain, swelling, shrinkage, surface mold and/or mildew, fungi, or any other physical property of the wood including but not limited to knots can occur.

# SOLID PANELS - 300



3' & 4' Height

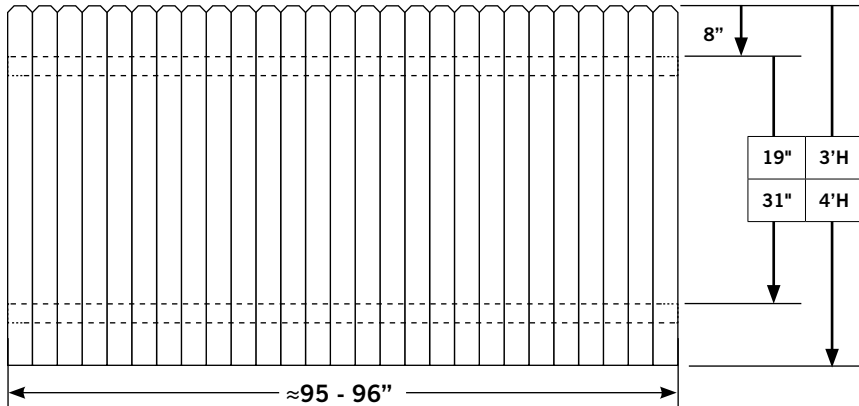

5' & 6' Height

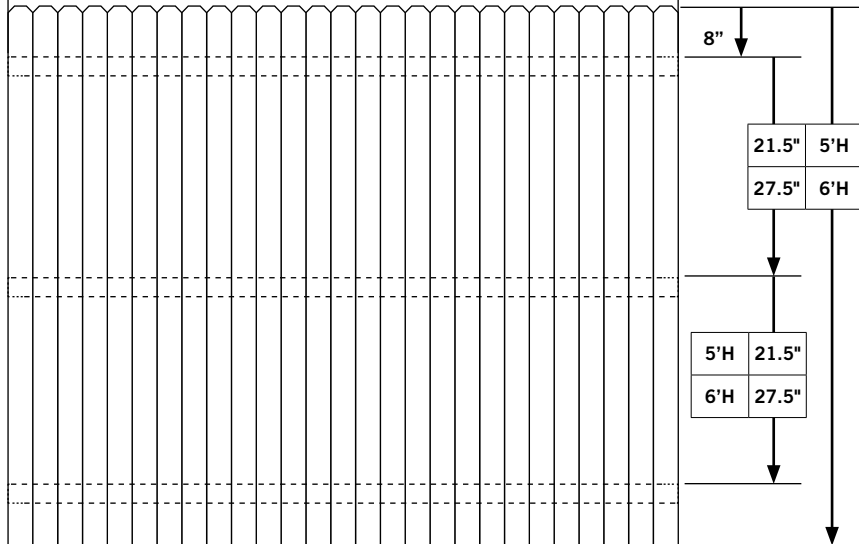

## 300 STYLE SOLID PANEL

3', 4', 5', 6' Height Cedar Solid Panels with #5 Style Picket Tops

BOARDS Nominal 1" x 4" / 27 Per Section

SPECIES White Cedar

NAILING TOP AND BOTTOM RAILS: Double Nailed  
MID-RAIL: End pickets are doubled nailed and the inside pickets are single nailed

NAILS Aluminum Spiral Nails

WIDTH 96" Nominal (Approx. 95" - 96")

RAILS STANDARD: 2" x 3" Nominal Cedar  
OPTIONAL: 2" x 3" Nominal Spruce  
OPTIONAL: Dowelled backrails - (Measurements may deviate from standard. Call for pricing and info)

GATES Matching gates available. Please CALL for more information

### PICKET TOP STYLES

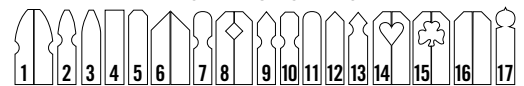

## SPRUCE BACKRAILS

Item #	Backrails	Description						Each
3462-300	SPRUCE 3'H	Solid	Spruce Backrails	Cedar Boards	#5 Style Picket Tops	Style 300		
4462-300	SPRUCE 4'H	Solid	Spruce Backrails	Cedar Boards	#5 Style Picket Tops	Style 300		
5462-300	SPRUCE 5'H	Solid	Spruce Backrails	Cedar Boards	#5 Style Picket Tops	Style 300		
6462-300	SPRUCE 6'H	Solid	Spruce Backrails	Cedar Boards	#5 Style Picket Tops	Style 300		
8462-300	SPRUCE 8'H	Solid	Spruce Backrails	Cedar Boards	#5 Style Picket Tops	Style 300		

## CEDAR BACKRAILS

Item #	Backrails	Description						Each
3472-300	CEDAR 3'H	Solid	Cedar Backrails	Cedar Boards	#5 Style Picket Tops	Style 300		
4472-300	CEDAR 4'H	Solid	Cedar Backrails	Cedar Boards	#5 Style Picket Tops	Style 300		
5472-300	CEDAR 5'H	Solid	Cedar Backrails	Cedar Boards	#5 Style Picket Tops	Style 300		
6472-300	CEDAR 6'H	Solid	Cedar Backrails	Cedar Boards	#5 Style Picket Tops	Style 300		
8472-300	CEDAR 8'H	Solid	Cedar Backrails	Cedar Boards	#5 Style Picket Tops	Style 300		

**MATCHING GATES AVAILABLE**

**PLEASE NOTE: ONCE DELIVERED, EASTERN WOOD FENCE IS NON-REFUNDABLE.**

Wood fence is a natural product and natural weathering including splitting, warping, twisting, checking, raised grain, swelling, shrinkage, surface mold and/or mildew, fungi, or any other physical property of the wood including but not limited to knots can occur.

# SOLID PANELS - 390



3' & 4' Height

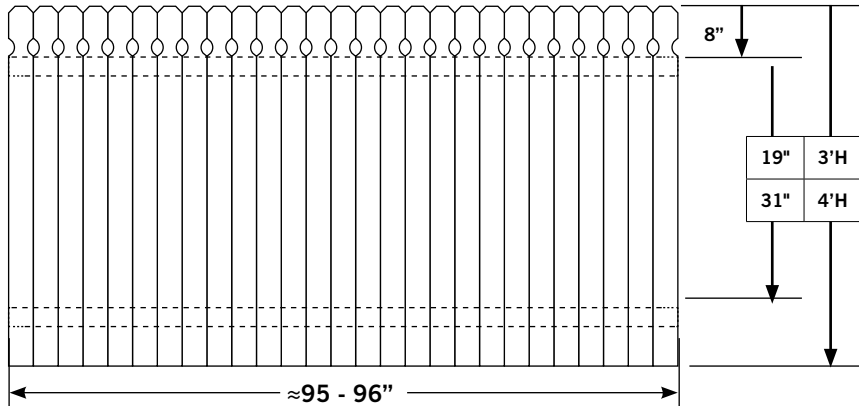

5' & 6' Height

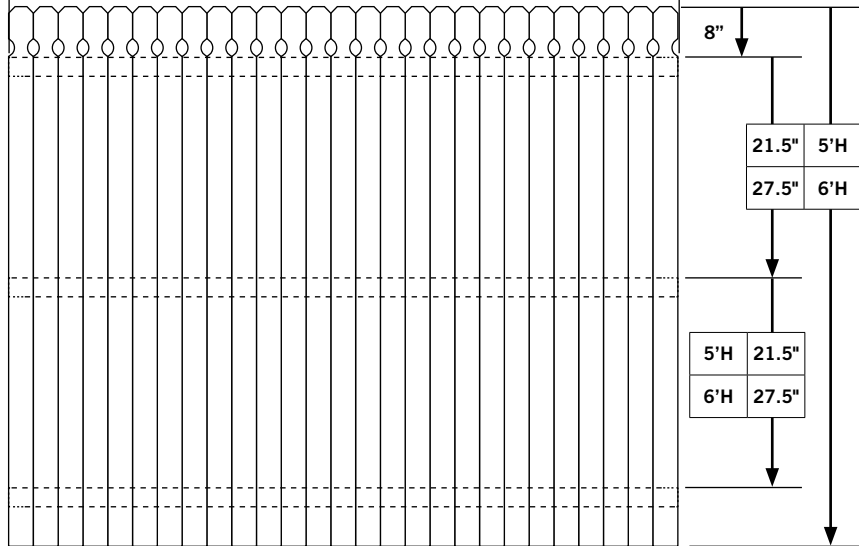

## 111 STYLE SOLID PANEL

3', 4', 5', 6' Height Cedar Solid Panels with #10 Style Picket Tops

BOARDS Nominal 1" x 4" / 27 Per Section

SPECIES White Cedar

NAILING TOP AND BOTTOM RAILS: Double Nailed  
MID-RAIL: End pickets are doubled nailed and the inside pickets are single nailed

NAILS Aluminum Spiral Nails

WIDTH 96" Nominal (Approx. 95" - 96")

RAILS STANDARD: 2" x 3" Nominal Cedar  
OPTIONAL: 2" x 3" Nominal Spruce  
OPTIONAL: Dowelled backrails - (Measurements may deviate from standard. Call for pricing and info)

GATES Matching gates available. Please CALL for more information

### PICKET TOP STYLES

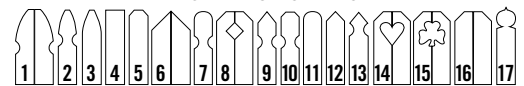

## SPRUCE BACKRAILS

Item #	Backrails	Description						Each
3462-390	SPRUCE 3'H	Solid	Spruce Backrails	Cedar Boards	#10 Style Picket Tops	Style 390		
4462-390	SPRUCE 4'H	Solid	Spruce Backrails	Cedar Boards	#10 Style Picket Tops	Style 390		
5462-390	SPRUCE 5'H	Solid	Spruce Backrails	Cedar Boards	#10 Style Picket Tops	Style 390		
6462-390	SPRUCE 6'H	Solid	Spruce Backrails	Cedar Boards	#10 Style Picket Tops	Style 390		
8462-390	SPRUCE 8'H	Solid	Spruce Backrails	Cedar Boards	#10 Style Picket Tops	Style 390		

## CEDAR BACKRAILS

Item #	Backrails	Description						Each
3472-390	CEDAR 3'H	Solid	Cedar Backrails	Cedar Boards	#10 Style Picket Tops	Style 390		
4472-390	CEDAR 4'H	Solid	Cedar Backrails	Cedar Boards	#10 Style Picket Tops	Style 390		
5472-390	CEDAR 5'H	Solid	Cedar Backrails	Cedar Boards	#10 Style Picket Tops	Style 390		
6472-390	CEDAR 6'H	Solid	Cedar Backrails	Cedar Boards	#10 Style Picket Tops	Style 390		
8472-390	CEDAR 8'H	Solid	Cedar Backrails	Cedar Boards	#10 Style Picket Tops	Style 390		

**MATCHING GATES AVAILABLE**

**PLEASE NOTE: ONCE DELIVERED, EASTERN WOOD FENCE IS NON-REFUNDABLE.**

Wood fence is a natural product and natural weathering including splitting, warping, twisting, checking, raised grain, swelling, shrinkage, surface mold and/or mildew, fungi, or any other physical property of the wood including but not limited to knots can occur.

# SOLID PANELS - 420

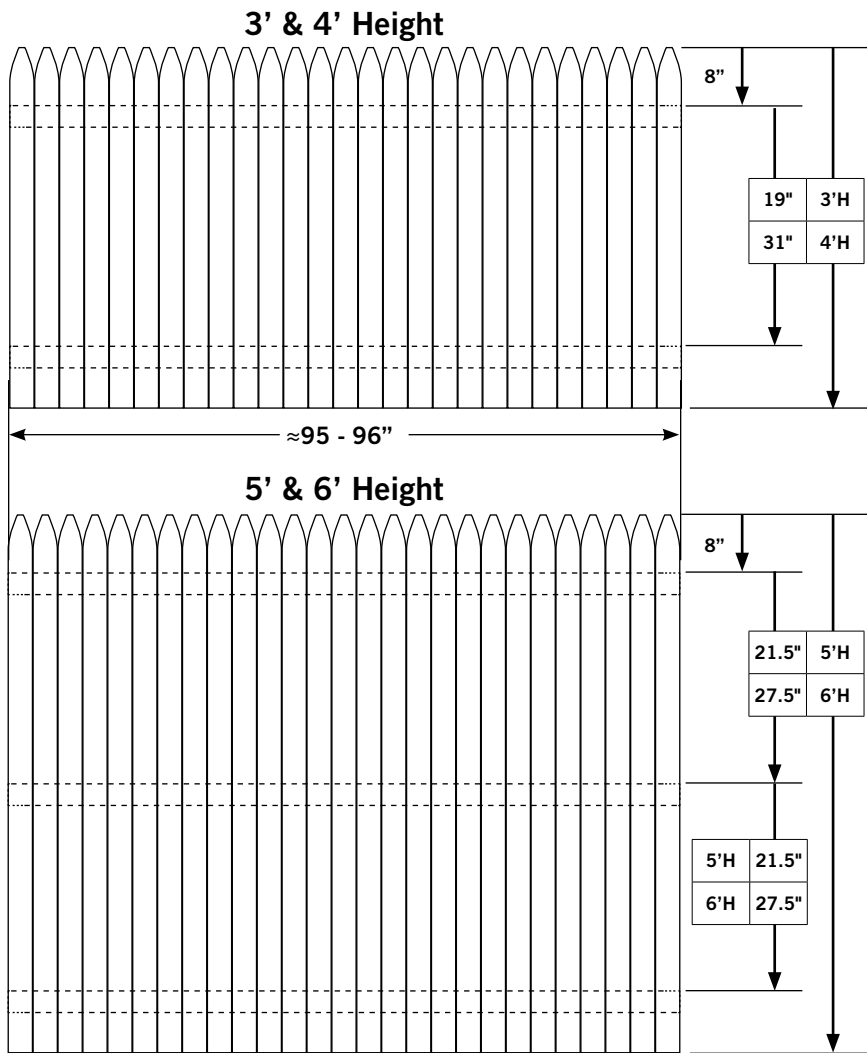

## 420 STYLE SOLID PANEL

3', 4', 5', 6' Height Cedar Solid Panels with #3 Style Picket Tops

BOARDS	Nominal 1" x 4" / 27 Per Section
SPECIES	White Cedar
NAILING	TOP AND BOTTOM RAILS: Double Nailed MID-RAIL: End pickets are doubled nailed and the inside pickets are single nailed
NAILS	Aluminum Spiral Nails
WIDTH	96" Nominal (Approx. 95" - 96")
RAILS	STANDARD: 2" x 3" Nominal Cedar OPTIONAL: 2" x 3" Nominal Spruce OPTIONAL: Dowelled backrails - (Measurements may deviate from standard. Call for pricing and info)
GATES	Matching gates available. Please CALL for more information

### PICKET TOP STYLES

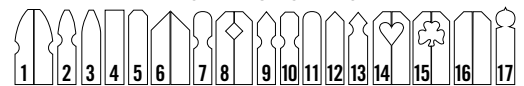

## SPRUCE BACKRAILS

Item #	Backrails	Description						Each
3462-420	SPRUCE 3'H	Solid	Spruce Backrails	Cedar Boards	#3 Style Picket Tops	Style 420		
4462-420	SPRUCE 4'H	Solid	Spruce Backrails	Cedar Boards	#3 Style Picket Tops	Style 420		
5462-420	SPRUCE 5'H	Solid	Spruce Backrails	Cedar Boards	#3 Style Picket Tops	Style 420		
6462-420	SPRUCE 6'H	Solid	Spruce Backrails	Cedar Boards	#3 Style Picket Tops	Style 420		
8462-420	SPRUCE 8'H	Solid	Spruce Backrails	Cedar Boards	#3 Style Picket Tops	Style 420		

## CEDAR BACKRAILS

Item #	Backrails	Description						Each
3472-420	CEDAR 3'H	Solid	Cedar Backrails	Cedar Boards	#3 Style Picket Tops	Style 420		
4472-420	CEDAR 4'H	Solid	Cedar Backrails	Cedar Boards	#3 Style Picket Tops	Style 420		
5472-420	CEDAR 5'H	Solid	Cedar Backrails	Cedar Boards	#3 Style Picket Tops	Style 420		
6472-420	CEDAR 6'H	Solid	Cedar Backrails	Cedar Boards	#3 Style Picket Tops	Style 420		
8472-420	CEDAR 8'H	Solid	Cedar Backrails	Cedar Boards	#3 Style Picket Tops	Style 420		

**MATCHING GATES AVAILABLE**

**PLEASE NOTE: ONCE DELIVERED, EASTERN WOOD FENCE IS NON-REFUNDABLE.**

Wood fence is a natural product and natural weathering including splitting, warping, twisting, checking, raised grain, swelling, shrinkage, surface mold and/or mildew, fungi, or any other physical property of the wood including but not limited to knots can occur.

# SOLID PANELS - 501



3' & 4' Height

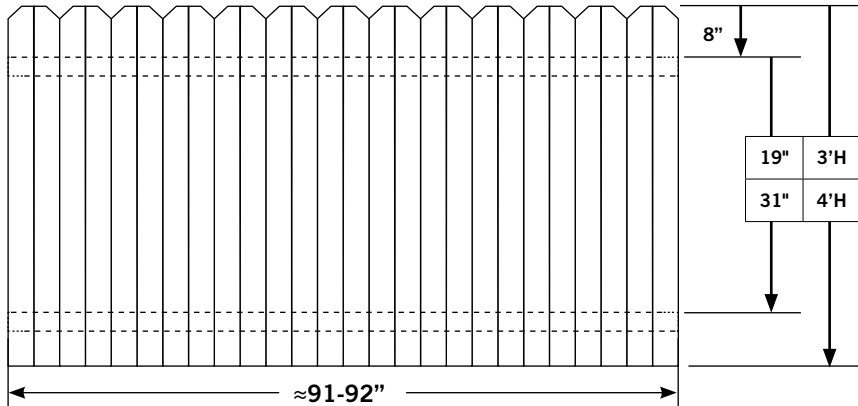

5' & 6' Height

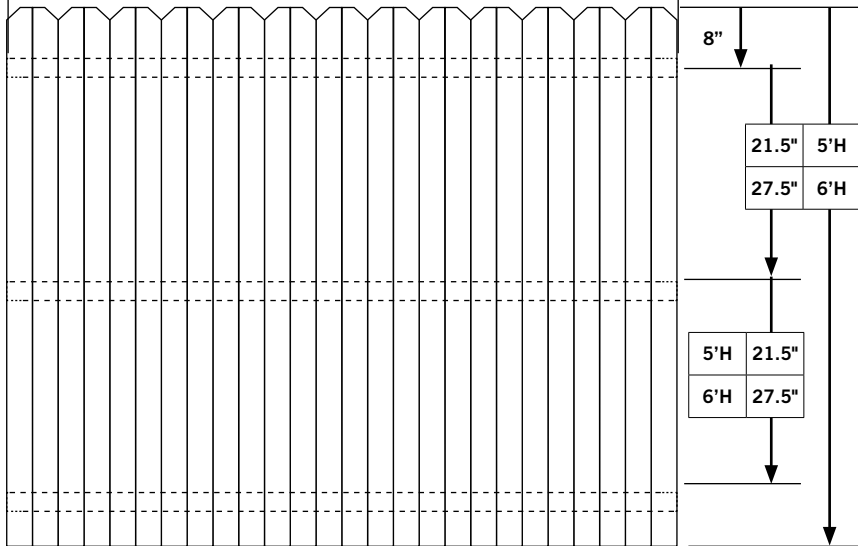

## 501 STYLE SOLID PANEL

3', 4', 5', 6' Height Cedar Solid Panels with #16 Style Picket Tops

BOARDS Nominal 1" x 4" / 26 Per Section

SPECIES White Cedar

NAILING TOP AND BOTTOM RAILS: Double Nailed  
MID-RAIL: End pickets are doubled nailed and the inside pickets are single nailed

NAILS Aluminum Spiral Nails

WIDTH 92" Nominal (Approx. 91" - 92")

RAILS STANDARD: 2" x 3" Nominal Cedar  
OPTIONAL: 2" x 3" Nominal Spruce  
OPTIONAL: Dowelled backrails - (Measurements may deviate from standard. Call for pricing and info)

GATES Matching gates available. Please CALL for more information

### PICKET TOP STYLES

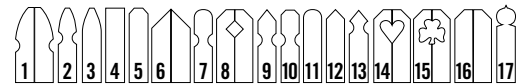

## SPRUCE BACKRAILS

Item #	Backrails	Description						Each
3462-501	SPRUCE 3'H	Solid	Spruce Backrails	Cedar Boards	#16 Style Picket Tops	Style 501		
4462-501	SPRUCE 4'H	Solid	Spruce Backrails	Cedar Boards	#16 Style Picket Tops	Style 501		
5462-501	SPRUCE 5'H	Solid	Spruce Backrails	Cedar Boards	#16 Style Picket Tops	Style 501		
6462-501	SPRUCE 6'H	Solid	Spruce Backrails	Cedar Boards	#16 Style Picket Tops	Style 501		
8462-501	SPRUCE 8'H	Solid	Spruce Backrails	Cedar Boards	#16 Style Picket Tops	Style 501		

## CEDAR BACKRAILS

Item #	Backrails	Description						Each
3472-501	CEDAR 3'H	Solid	Cedar Backrails	Cedar Boards	#16 Style Picket Tops	Style 501		
4472-501	CEDAR 4'H	Solid	Cedar Backrails	Cedar Boards	#16 Style Picket Tops	Style 501		
5472-501	CEDAR 5'H	Solid	Cedar Backrails	Cedar Boards	#16 Style Picket Tops	Style 501		
6472-501	CEDAR 6'H	Solid	Cedar Backrails	Cedar Boards	#16 Style Picket Tops	Style 501		
8472-501	CEDAR 8'H	Solid	Cedar Backrails	Cedar Boards	#16 Style Picket Tops	Style 501		

**MATCHING GATES AVAILABLE**

**PLEASE NOTE: ONCE DELIVERED, EASTERN WOOD FENCE IS NON-REFUNDABLE.**

Wood fence is a natural product and natural weathering including splitting, warping, twisting, checking, raised grain, swelling, shrinkage, surface mold and/or mildew, fungi, or any other physical property of the wood including but not limited to knots can occur.

# SOLID PANELS - 502



3' & 4' Height

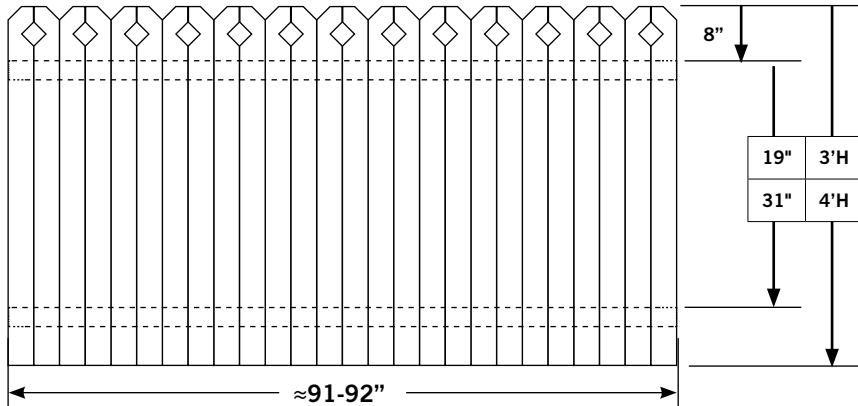

5' & 6' Height

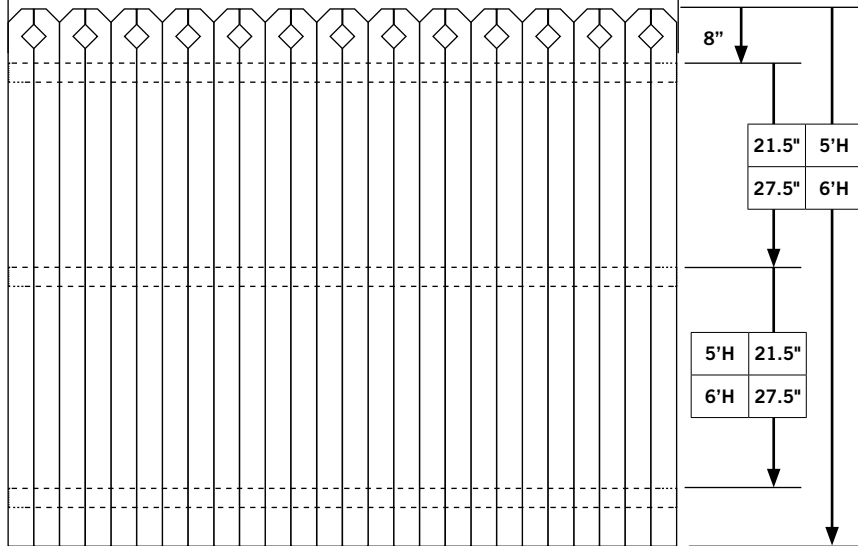

## 502 STYLE SOLID PANEL

3', 4', 5', 6' Height Cedar Solid Panels with #8 Style Picket Tops

BOARDS Nominal 1" x 4" / 26 Per Section

SPECIES White Cedar

NAILING TOP AND BOTTOM RAILS: Double Nailed  
MID-RAIL: End pickets are doubled nailed and the inside pickets are single nailed

NAILS Aluminum Spiral Nails

WIDTH 92" Nominal (Approx. 91" - 92")

RAILS STANDARD: 2" x 3" Nominal Cedar  
OPTIONAL: 2" x 3" Nominal Spruce  
OPTIONAL: Dowelled backrails - (Measurements may deviate from standard. Call for pricing and info)

GATES Matching gates available. Please CALL for more information

### PICKET TOP STYLES

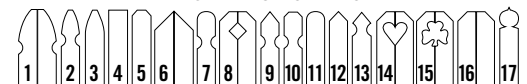

## SPRUCE BACKRAILS

Item #	Backrails	Description						Each
3462-502	SPRUCE 3'H	Solid	Spruce Backrails	Cedar Boards	#8 Style Picket Tops	Style 502		
4462-502	SPRUCE 4'H	Solid	Spruce Backrails	Cedar Boards	#8 Style Picket Tops	Style 502		
5462-502	SPRUCE 5'H	Solid	Spruce Backrails	Cedar Boards	#8 Style Picket Tops	Style 502		
6462-502	SPRUCE 6'H	Solid	Spruce Backrails	Cedar Boards	#8 Style Picket Tops	Style 502		
8462-502	SPRUCE 8'H	Solid	Spruce Backrails	Cedar Boards	#8 Style Picket Tops	Style 502		

## CEDAR BACKRAILS

Item #	Backrails	Description						Each
3472-502	CEDAR 3'H	Solid	Cedar Backrails	Cedar Boards	#8 Style Picket Tops	Style 502		
4472-502	CEDAR 4'H	Solid	Cedar Backrails	Cedar Boards	#8 Style Picket Tops	Style 502		
5472-502	CEDAR 5'H	Solid	Cedar Backrails	Cedar Boards	#8 Style Picket Tops	Style 502		
6472-502	CEDAR 6'H	Solid	Cedar Backrails	Cedar Boards	#8 Style Picket Tops	Style 502		
8472-502	CEDAR 8'H	Solid	Cedar Backrails	Cedar Boards	#8 Style Picket Tops	Style 502		

**MATCHING GATES AVAILABLE**

**PLEASE NOTE: ONCE DELIVERED, EASTERN WOOD FENCE IS NON-REFUNDABLE.**

Wood fence is a natural product and natural weathering including splitting, warping, twisting, checking, raised grain, swelling, shrinkage, surface mold and/or mildew, fungi, or any other physical property of the wood including but not limited to knots can occur.

# SOLID PANELS - 502H



3' & 4' Height

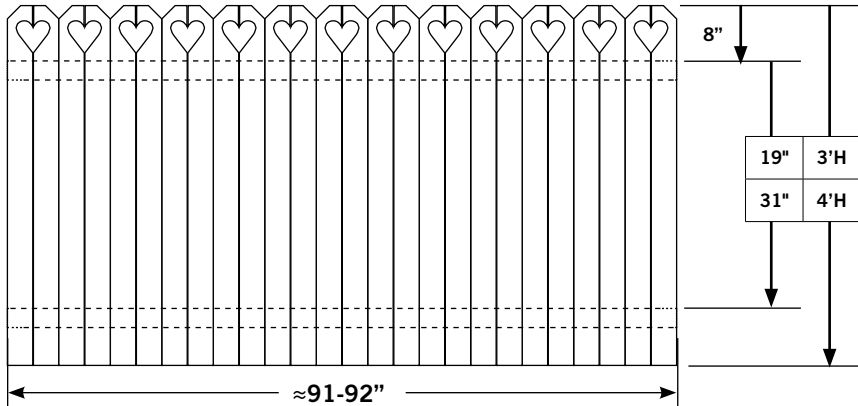

5' & 6' Height

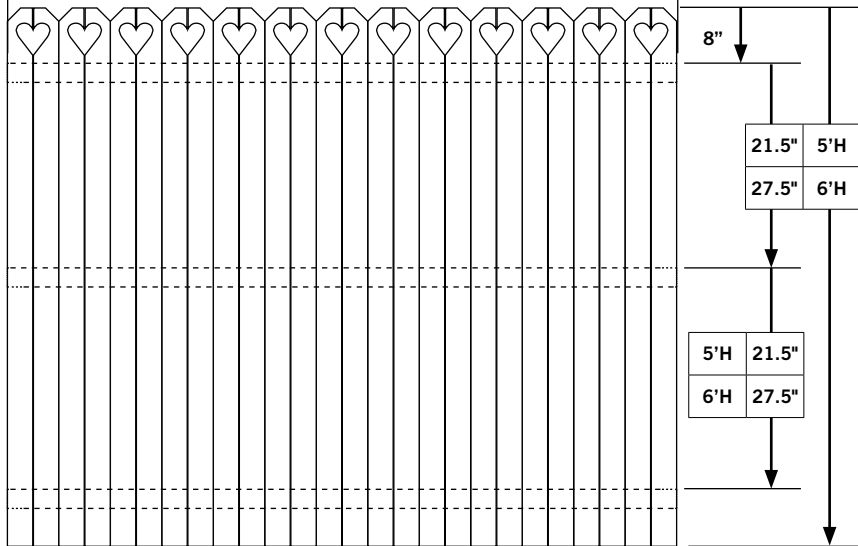

## 502H STYLE SOLID PANEL

3', 4', 5', 6' Height Cedar Solid Panels with #14 Style Picket Tops

BOARDS Nominal 1" x 4" / 26 Per Section

SPECIES White Cedar

NAILING TOP AND BOTTOM RAILS: Double Nailed  
MID-RAIL: End pickets are doubled nailed and the inside pickets are single nailed

NAILS Aluminum Spiral Nails

WIDTH 92" Nominal (Approx. 91" - 92")

RAILS STANDARD: 2" x 3" Nominal Cedar  
OPTIONAL: 2" x 3" Nominal Spruce  
OPTIONAL: Dowelled backrails - (Measurements may deviate from standard. Call for pricing and info)

GATES Matching gates available. Please CALL for more information

### PICKET TOP STYLES

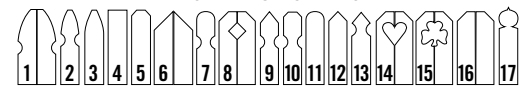

## SPRUCE BACKRAILS

Item #	Backrails	Description						Each
3462-502H	SPRUCE 3'H	Solid	Spruce Backrails	Cedar Boards	#14 Style Picket Tops	Style 502H		
4462-502H	SPRUCE 4'H	Solid	Spruce Backrails	Cedar Boards	#14 Style Picket Tops	Style 502H		
5462-502H	SPRUCE 5'H	Solid	Spruce Backrails	Cedar Boards	#14 Style Picket Tops	Style 502H		
6462-502H	SPRUCE 6'H	Solid	Spruce Backrails	Cedar Boards	#14 Style Picket Tops	Style 502H		
8462-502H	SPRUCE 8'H	Solid	Spruce Backrails	Cedar Boards	#14 Style Picket Tops	Style 502H		

## CEDAR BACKRAILS

Item #	Backrails	Description						Each
3472-502H	CEDAR 3'H	Solid	Cedar Backrails	Cedar Boards	#14 Style Picket Tops	Style 502H		
4472-502H	CEDAR 4'H	Solid	Cedar Backrails	Cedar Boards	#14 Style Picket Tops	Style 502H		
5472-502H	CEDAR 5'H	Solid	Cedar Backrails	Cedar Boards	#14 Style Picket Tops	Style 502H		
6472-502H	CEDAR 6'H	Solid	Cedar Backrails	Cedar Boards	#14 Style Picket Tops	Style 502H		
8472-502H	CEDAR 8'H	Solid	Cedar Backrails	Cedar Boards	#14 Style Picket Tops	Style 502H		

**MATCHING GATES AVAILABLE**

**PLEASE NOTE: ONCE DELIVERED, EASTERN WOOD FENCE IS NON-REFUNDABLE.**

Wood fence is a natural product and natural weathering including splitting, warping, twisting, checking, raised grain, swelling, shrinkage, surface mold and/or mildew, fungi, or any other physical property of the wood including but not limited to knots can occur.

# SOLID PANELS - 503

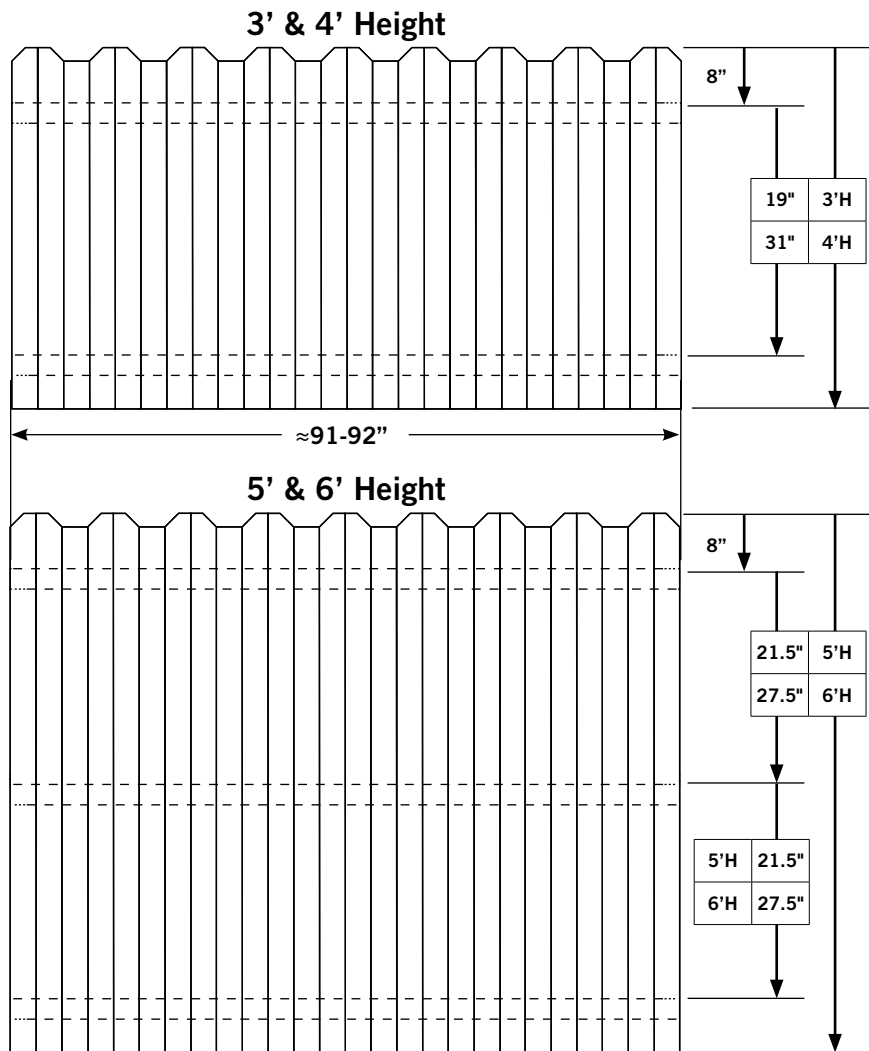

## 503 STYLE SOLID PANEL

3', 4', 5', 6' Height Cedar Solid Panels with #16 and #4 Style Picket Tops

BOARDS	Nominal 1" x 4" / 26 Per Section
SPECIES	White Cedar
NAILING	TOP AND BOTTOM RAILS: Double Nailed MID-RAIL: End pickets are doubled nailed and the inside pickets are single nailed
NAILS	Aluminum Spiral Nails
WIDTH	92" Nominal (Approx. 91" - 92")
RAILS	STANDARD: 2" x 3" Nominal Cedar OPTIONAL: 2" x 3" Nominal Spruce OPTIONAL: Dowelled backrails - (Measurements may deviate from standard. Call for pricing and info)
GATES	Matching gates available. Please CALL for more information



## SPRUCE BACKRAILS

Item #	Backrails	Description						Each
3462-503	SPRUCE 3'H	Solid	Spruce Backrails	Cedar Boards	#16 and #4 Style Picket Tops	Style 503		
4462-503	SPRUCE 4'H	Solid	Spruce Backrails	Cedar Boards	#16 and #4 Style Picket Tops	Style 503		
5462-503	SPRUCE 5'H	Solid	Spruce Backrails	Cedar Boards	#16 and #4 Style Picket Tops	Style 503		
6462-503	SPRUCE 6'H	Solid	Spruce Backrails	Cedar Boards	#16 and #4 Style Picket Tops	Style 503		
8462-503	SPRUCE 8'H	Solid	Spruce Backrails	Cedar Boards	#16 and #4 Style Picket Tops	Style 503		

## CEDAR BACKRAILS

Item #	Backrails	Description						Each
3472-503	CEDAR 3'H	Solid	Cedar Backrails	Cedar Boards	#16 and #4 Style Picket Tops	Style 503		
4472-503	CEDAR 4'H	Solid	Cedar Backrails	Cedar Boards	#16 and #4 Style Picket Tops	Style 503		
5472-503	CEDAR 5'H	Solid	Cedar Backrails	Cedar Boards	#16 and #4 Style Picket Tops	Style 503		
6472-503	CEDAR 6'H	Solid	Cedar Backrails	Cedar Boards	#16 and #4 Style Picket Tops	Style 503		
8472-503	CEDAR 8'H	Solid	Cedar Backrails	Cedar Boards	#16 and #4 Style Picket Tops	Style 503		

**MATCHING GATES AVAILABLE**

**PLEASE NOTE: ONCE DELIVERED, EASTERN WOOD FENCE IS NON-REFUNDABLE.**

Wood fence is a natural product and natural weathering including splitting, warping, twisting, checking, raised grain, swelling, shrinkage, surface mold and/or mildew, fungi, or any other physical property of the wood including but not limited to knots can occur.

# SOLID PANELS - 600

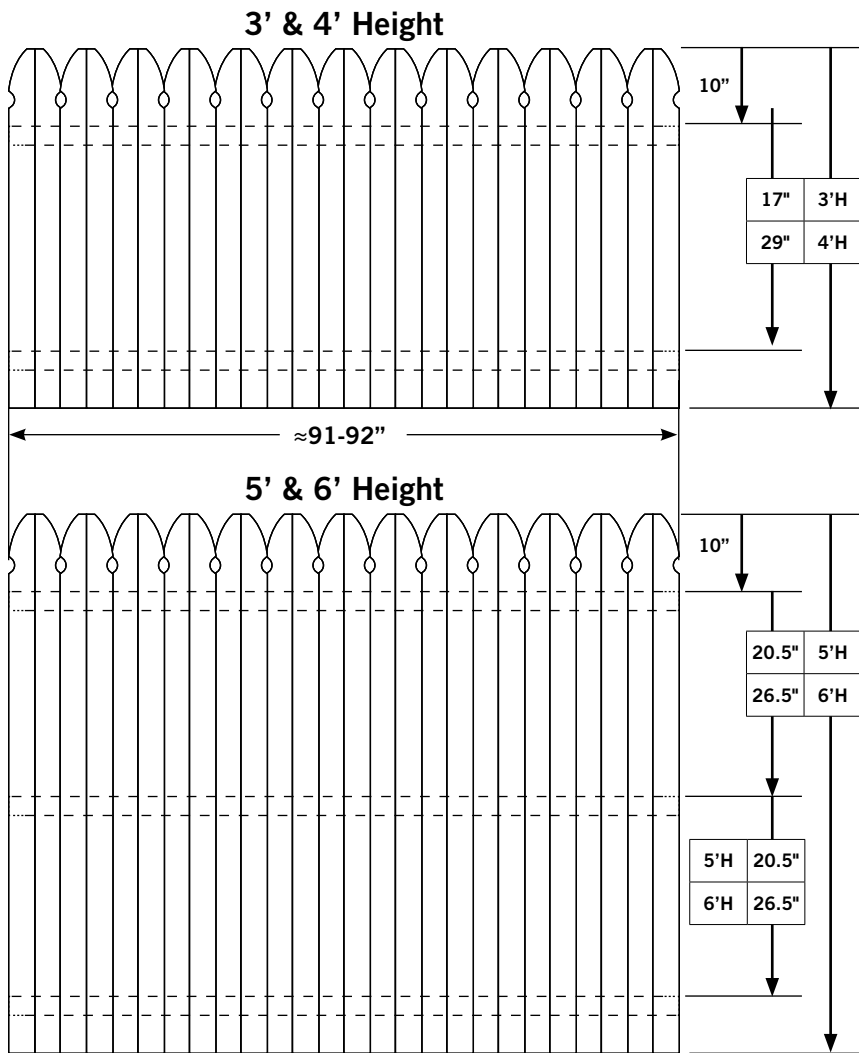

## 600 STYLE SOLID PANEL

3', 4', 5', 6' Height Cedar Solid Panels with #1 Style Picket Tops

BOARDS Nominal 1" x 4" / 26 Per Section

SPECIES White Cedar

NAILING TOP AND BOTTOM RAILS: Double Nailed  
MID-RAIL: End pickets are doubled nailed and the inside pickets are single nailed

NAILS Aluminum Spiral Nails

WIDTH 92" Nominal (Approx. 91" - 92")

RAILS STANDARD: 2" x 3" Nominal Cedar  
OPTIONAL: 2" x 3" Nominal Spruce  
OPTIONAL: Dowelled backrails - (Measurements may deviate from standard. Call for pricing and info)

GATES Matching gates available. Please CALL for more information

### PICKET TOP STYLES

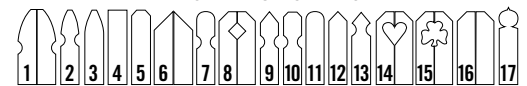

## SPRUCE BACKRAILS

Item #	Backrails	Description						Each
3462-600	SPRUCE 3'H	Solid	Spruce Backrails	Cedar Boards	#1 Style Picket Tops	Style 600		
4462-600	SPRUCE 4'H	Solid	Spruce Backrails	Cedar Boards	#1 Style Picket Tops	Style 600		
5462-600	SPRUCE 5'H	Solid	Spruce Backrails	Cedar Boards	#1 Style Picket Tops	Style 600		
6462-600	SPRUCE 6'H	Solid	Spruce Backrails	Cedar Boards	#1 Style Picket Tops	Style 600		
8462-600	SPRUCE 8'H	Solid	Spruce Backrails	Cedar Boards	#1 Style Picket Tops	Style 600		

## CEDAR BACKRAILS

Item #	Backrails	Description						Each
3472-600	CEDAR 3'H	Solid	Cedar Backrails	Cedar Boards	#1 Style Picket Tops	Style 600		
4472-600	CEDAR 4'H	Solid	Cedar Backrails	Cedar Boards	#1 Style Picket Tops	Style 600		
5472-600	CEDAR 5'H	Solid	Cedar Backrails	Cedar Boards	#1 Style Picket Tops	Style 600		
6472-600	CEDAR 6'H	Solid	Cedar Backrails	Cedar Boards	#1 Style Picket Tops	Style 600		
8472-600	CEDAR 8'H	Solid	Cedar Backrails	Cedar Boards	#1 Style Picket Tops	Style 600		

**MATCHING GATES AVAILABLE**

**PLEASE NOTE: ONCE DELIVERED, EASTERN WOOD FENCE IS NON-REFUNDABLE.**

Wood fence is a natural product and natural weathering including splitting, warping, twisting, checking, raised grain, swelling, shrinkage, surface mold and/or mildew, fungi, or any other physical property of the wood including but not limited to knots can occur.

# SOLID PANELS - 990



3' & 4' Height

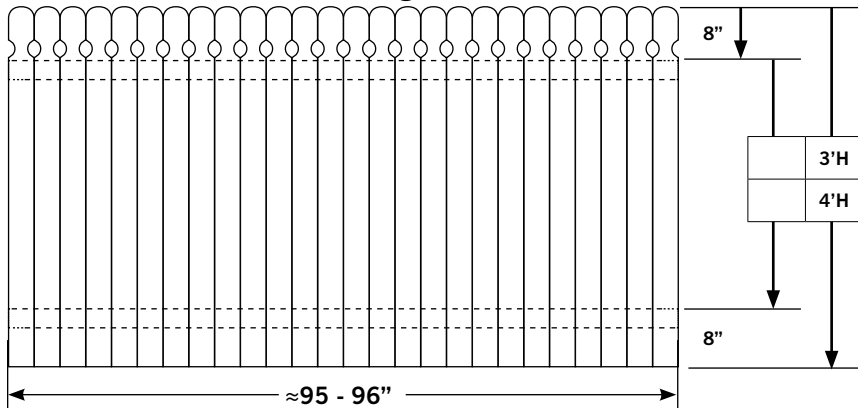

5' & 6' Height

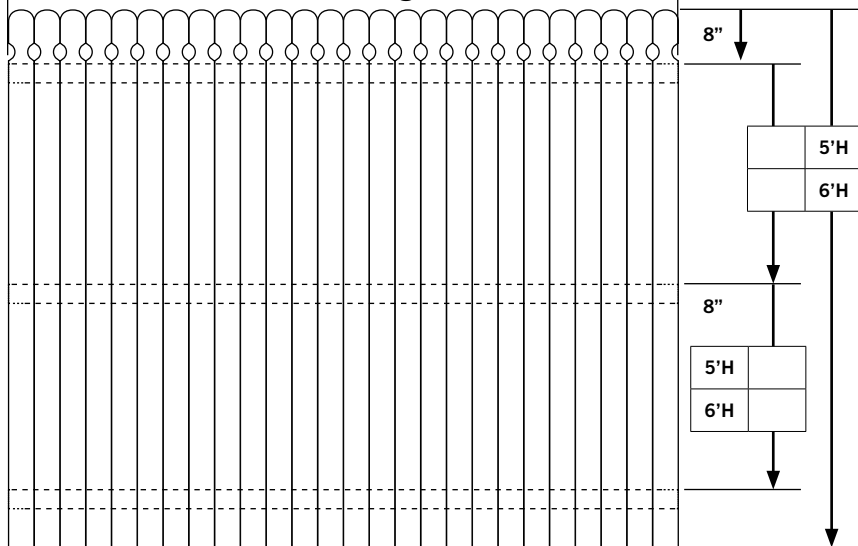

## 990 STYLE SOLID PANEL

3', 4', 5', 6' Height Cedar Solid Panels with #7 Style Picket Tops

BOARDS	Nominal 1" x 4" / 27 Per Section
SPECIES	White Cedar
NAILING	TOP AND BOTTOM RAILS: Double Nailed MID-RAIL: End pickets are doubled nailed and the inside pickets are single nailed
NAILS	Aluminum Spiral Nails
WIDTH	96" Nominal (Approx. 95" - 96")
RAILS	STANDARD: 2" x 3" Nominal Cedar OPTIONAL: 2" x 3" Nominal Spruce OPTIONAL: Dowelled backrails - (Measurements may deviate from standard. Call for pricing and info)
GATES	Matching gates available. Please CALL for more information

### PICKET TOP STYLES

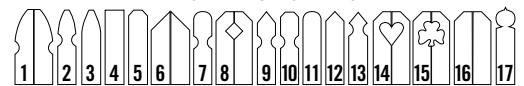

## SPRUCE BACKRAILS

Item #	Backrails	Description						Each
3462-990	SPRUCE 3'H	Solid	Spruce Backrails	Cedar Boards	#7 Style Picket Tops	Style 990		
4462-990	SPRUCE 4'H	Solid	Spruce Backrails	Cedar Boards	#7 Style Picket Tops	Style 990		
5462-990	SPRUCE 5'H	Solid	Spruce Backrails	Cedar Boards	#7 Style Picket Tops	Style 990		
6462-990	SPRUCE 6'H	Solid	Spruce Backrails	Cedar Boards	#7 Style Picket Tops	Style 990		
8462-990	SPRUCE 8'H	Solid	Spruce Backrails	Cedar Boards	#7 Style Picket Tops	Style 990		

## CEDAR BACKRAILS

Item #	Backrails	Description						Each
3472-990	CEDAR 3'H	Solid	Cedar Backrails	Cedar Boards	#7 Style Picket Tops	Style 990		
4472-990	CEDAR 4'H	Solid	Cedar Backrails	Cedar Boards	#7 Style Picket Tops	Style 990		
5472-990	CEDAR 5'H	Solid	Cedar Backrails	Cedar Boards	#7 Style Picket Tops	Style 990		
6472-990	CEDAR 6'H	Solid	Cedar Backrails	Cedar Boards	#7 Style Picket Tops	Style 990		
8472-990	CEDAR 8'H	Solid	Cedar Backrails	Cedar Boards	#7 Style Picket Tops	Style 990		

**MATCHING GATES AVAILABLE**

**PLEASE NOTE: ONCE DELIVERED, EASTERN WOOD FENCE IS NON-REFUNDABLE.**

Wood fence is a natural product and natural weathering including splitting, warping, twisting, checking, raised grain, swelling, shrinkage, surface mold and/or mildew, fungi, or any other physical property of the wood including but not limited to knots can occur.

# SOLID SHAPED - POPULAR STYLES



## WHITE CEDAR SOLID SHAPED PANELS

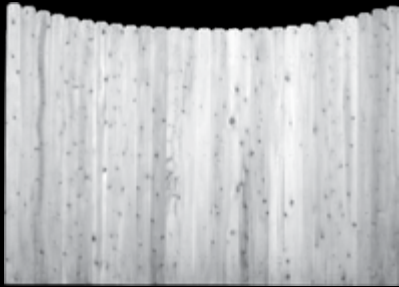

**301**  
SCALLOP

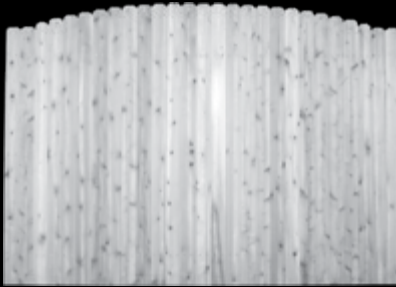

**303**  
CROWN

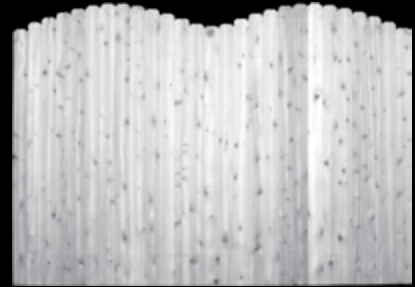

**304**  
DOUBLE CROWN



**202**  
DOUBLE CONCAVE

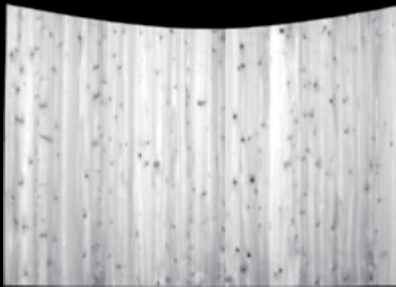

**203**  
CONCAVE

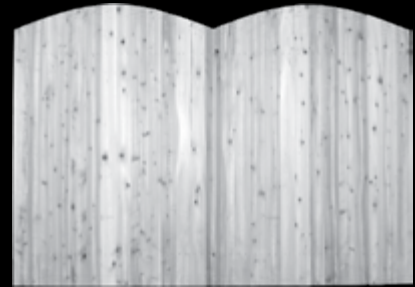

**204**  
DOUBLE CONVEX

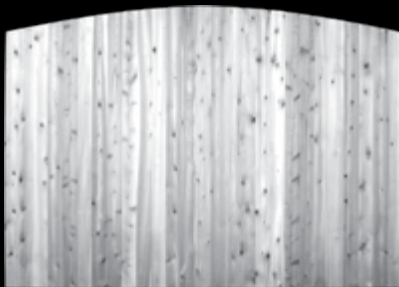

**206**  
CONVEX

# SOLID PANELS - 301

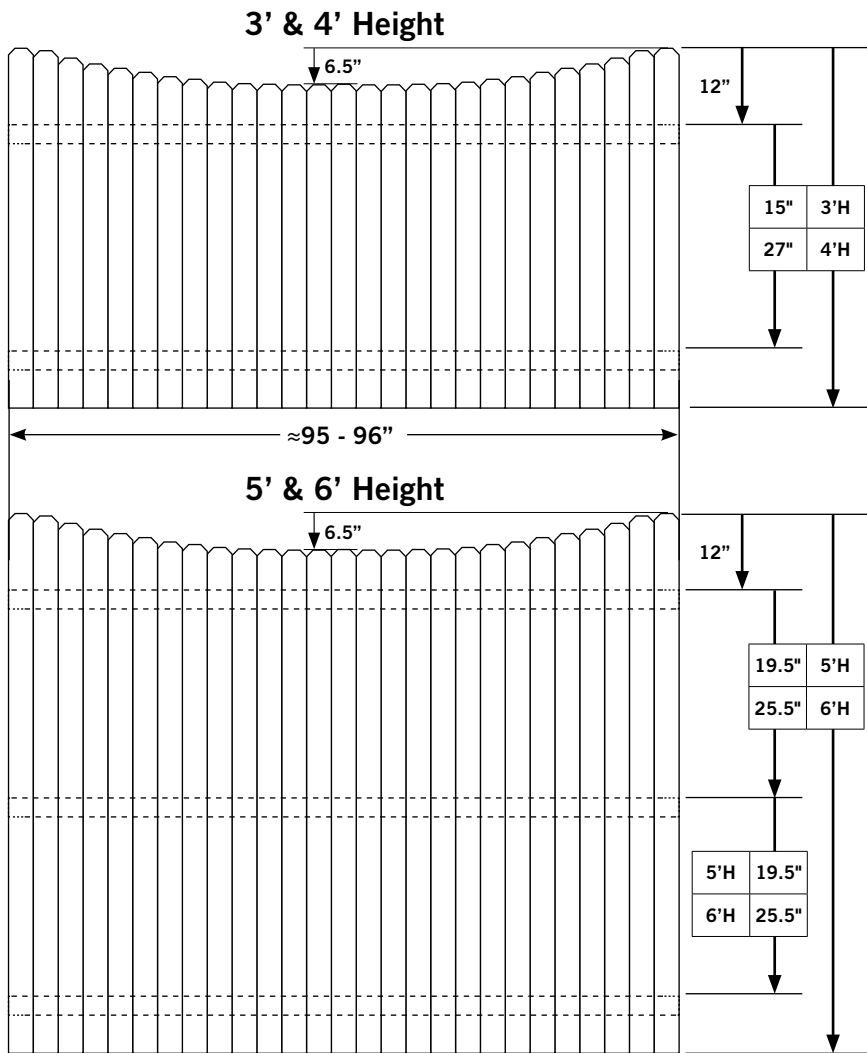

## 301 STYLE SOLID PANEL

3', 4', 5', 6' Height Cedar Solid Panels with #5 Style Picket Tops

BOARDS Nominal 1" x 4" / 27 Per Section

SPECIES White Cedar

NAILING TOP AND BOTTOM RAILS: Double Nailed  
MID-RAIL: End pickets are doubled nailed and the inside pickets are single nailed

NAILS Aluminum Spiral Nails

WIDTH 96" Nominal (Approx. 95" - 96")

RAILS STANDARD: 2" x 3" Nominal Cedar  
OPTIONAL: 2" x 3" Nominal Spruce  
OPTIONAL: Dowelled backrails - (Measurements may deviate from standard. Call for pricing and info)

GATES Matching gates available. Please CALL for more information

### PICKET TOP STYLES

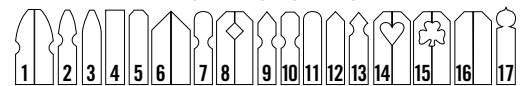

## SPRUCE BACKRAILS

Item #	Backrails	Description						Each
3462-301	SPRUCE 3'H	Solid	Spruce Backrails	Cedar Boards	#5 Style Picket Tops	Style 301		
4462-301	SPRUCE 4'H	Solid	Spruce Backrails	Cedar Boards	#5 Style Picket Tops	Style 301		
5462-301	SPRUCE 5'H	Solid	Spruce Backrails	Cedar Boards	#5 Style Picket Tops	Style 301		
6462-301	SPRUCE 6'H	Solid	Spruce Backrails	Cedar Boards	#5 Style Picket Tops	Style 301		
8462-301	SPRUCE 8'H	Solid	Spruce Backrails	Cedar Boards	#5 Style Picket Tops	Style 301		

## CEDAR BACKRAILS

Item #	Backrails	Description						Each
3472-301	CEDAR 3'H	Solid	Cedar Backrails	Cedar Boards	#5 Style Picket Tops	Style 301		
4472-301	CEDAR 4'H	Solid	Cedar Backrails	Cedar Boards	#5 Style Picket Tops	Style 301		
5472-301	CEDAR 5'H	Solid	Cedar Backrails	Cedar Boards	#5 Style Picket Tops	Style 301		
6472-301	CEDAR 6'H	Solid	Cedar Backrails	Cedar Boards	#5 Style Picket Tops	Style 301		
8472-301	CEDAR 8'H	Solid	Cedar Backrails	Cedar Boards	#5 Style Picket Tops	Style 301		

**MATCHING GATES AVAILABLE**

**PLEASE NOTE: ONCE DELIVERED, EASTERN WOOD FENCE IS NON-REFUNDABLE.**

Wood fence is a natural product and natural weathering including splitting, warping, twisting, checking, raised grain, swelling, shrinkage, surface mold and/or mildew, fungi, or any other physical property of the wood including but not limited to knots can occur.

# SOLID PANELS - 303



3' & 4' Height

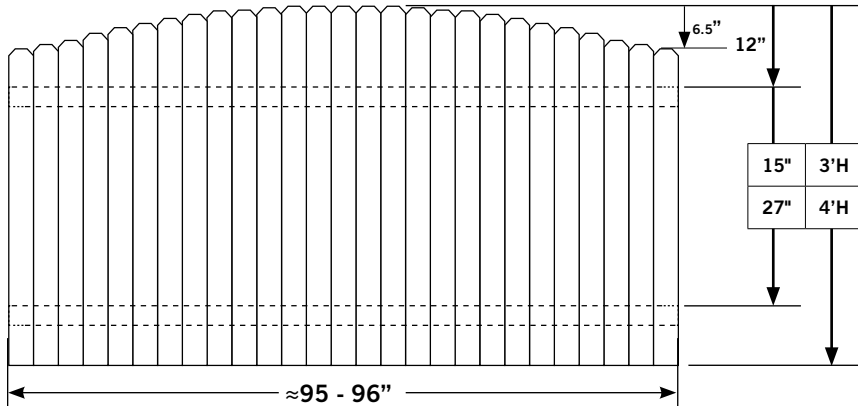

5' & 6' Height

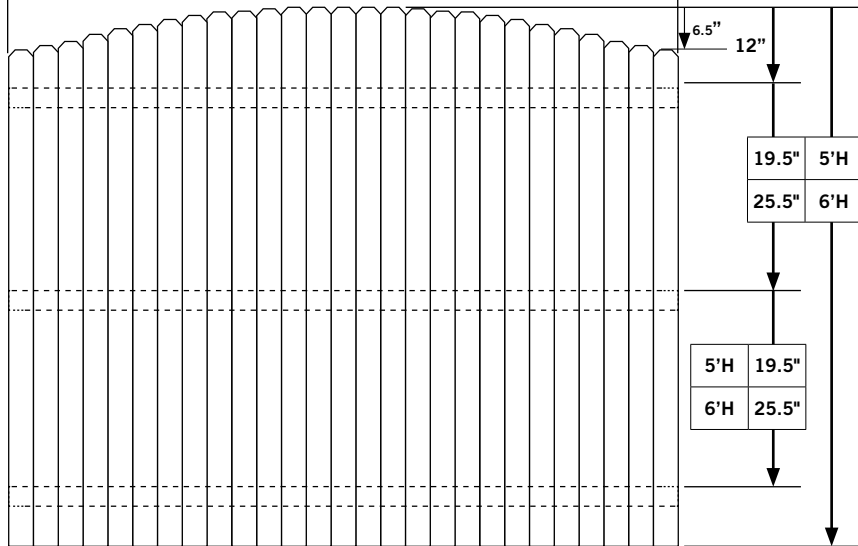

## 303 STYLE SOLID PANEL

3', 4', 5', 6' Height Cedar Solid Panels with #5 Style Picket Tops

BOARDS Nominal 1" x 4" / 27 Per Section

SPECIES White Cedar

NAILING TOP AND BOTTOM RAILS: Double Nailed  
MID-RAIL: End pickets are doubled nailed and the inside pickets are single nailed

NAILS Aluminum Spiral Nails

WIDTH 96" Nominal (Approx. 95" - 96")

RAILS STANDARD: 2" x 3" Nominal Cedar  
OPTIONAL: 2" x 3" Nominal Spruce  
OPTIONAL: Dowelled backrails - (Measurements may deviate from standard. Call for pricing and info)

GATES Matching gates available. Please CALL for more information

### PICKET TOP STYLES

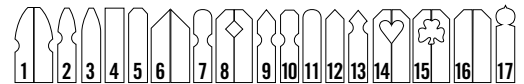

## SPRUCE BACKRAILS

Item #	Backrails	Description						Each
3462-303	SPRUCE 3'H	Solid	Spruce Backrails	Cedar Boards	#5 Style Picket Tops	Style 303		
4462-303	SPRUCE 4'H	Solid	Spruce Backrails	Cedar Boards	#5 Style Picket Tops	Style 303		
5462-303	SPRUCE 5'H	Solid	Spruce Backrails	Cedar Boards	#5 Style Picket Tops	Style 303		
6462-303	SPRUCE 6'H	Solid	Spruce Backrails	Cedar Boards	#5 Style Picket Tops	Style 303		
8462-303	SPRUCE 8'H	Solid	Spruce Backrails	Cedar Boards	#5 Style Picket Tops	Style 303		

## CEDAR BACKRAILS

Item #	Backrails	Description						Each
3472-303	CEDAR 3'H	Solid	Cedar Backrails	Cedar Boards	#5 Style Picket Tops	Style 303		
4472-303	CEDAR 4'H	Solid	Cedar Backrails	Cedar Boards	#5 Style Picket Tops	Style 303		
5472-303	CEDAR 5'H	Solid	Cedar Backrails	Cedar Boards	#5 Style Picket Tops	Style 303		
6472-303	CEDAR 6'H	Solid	Cedar Backrails	Cedar Boards	#5 Style Picket Tops	Style 303		
8472-303	CEDAR 8'H	Solid	Cedar Backrails	Cedar Boards	#5 Style Picket Tops	Style 303		

**MATCHING GATES AVAILABLE**

**PLEASE NOTE: ONCE DELIVERED, EASTERN WOOD FENCE IS NON-REFUNDABLE.**

Wood fence is a natural product and natural weathering including splitting, warping, twisting, checking, raised grain, swelling, shrinkage, surface mold and/or mildew, fungi, or any other physical property of the wood including but not limited to knots can occur.

# SOLID PANELS - 304



3' & 4' Height

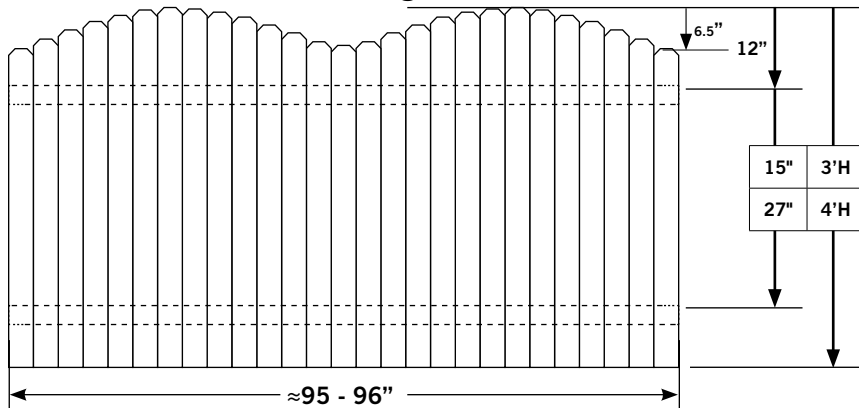

5' & 6' Height

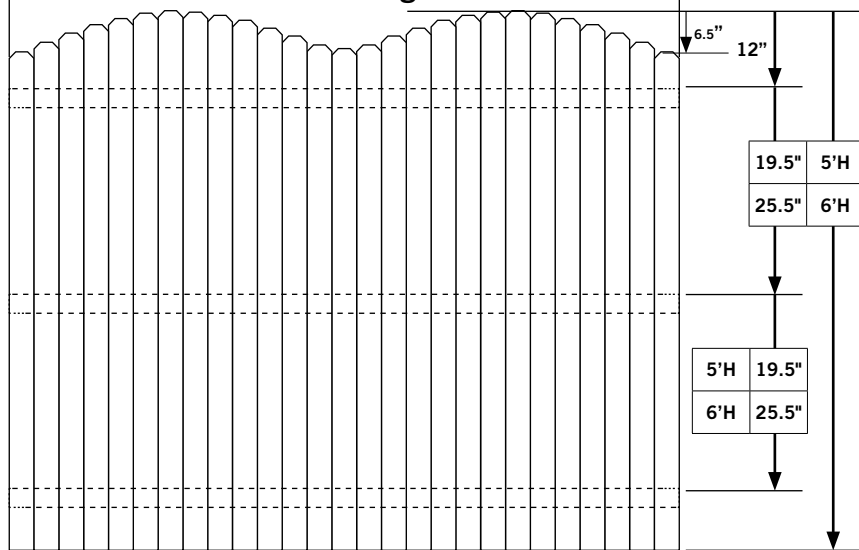

## 304 STYLE SOLID PANEL

3', 4', 5', 6' Height Cedar Solid Panels with #5 Style Picket Tops

BOARDS Nominal 1" x 4" / 27 Per Section

SPECIES White Cedar

NAILING TOP AND BOTTOM RAILS: Double Nailed  
MID-RAIL: End pickets are doubled nailed and the inside pickets are single nailed

NAILS Aluminum Spiral Nails

WIDTH 96" Nominal (Approx. 95" - 96")

RAILS STANDARD: 2" x 3" Nominal Cedar  
OPTIONAL: 2" x 3" Nominal Spruce  
OPTIONAL: Dowelled backrails - (Measurements may deviate from standard. Call for pricing and info)

GATES Matching gates available. Please CALL for more information

PICKET TOP STYLES

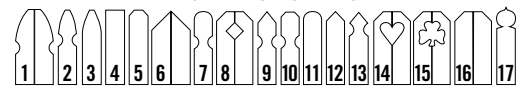

## SPRUCE BACKRAILS

Item #	Backrails	Description						Each
3462-304	SPRUCE 3'H	Solid	Spruce Backrails	Cedar Boards	#5 Style Picket Tops	Style 304		
4462-304	SPRUCE 4'H	Solid	Spruce Backrails	Cedar Boards	#5 Style Picket Tops	Style 304		
5462-304	SPRUCE 5'H	Solid	Spruce Backrails	Cedar Boards	#5 Style Picket Tops	Style 304		
6462-304	SPRUCE 6'H	Solid	Spruce Backrails	Cedar Boards	#5 Style Picket Tops	Style 304		
8462-304	SPRUCE 8'H	Solid	Spruce Backrails	Cedar Boards	#5 Style Picket Tops	Style 304		

## CEDAR BACKRAILS

Item #	Backrails	Description						Each
3472-304	CEDAR 3'H	Solid	Cedar Backrails	Cedar Boards	#5 Style Picket Tops	Style 304		
4472-304	CEDAR 4'H	Solid	Cedar Backrails	Cedar Boards	#5 Style Picket Tops	Style 304		
5472-304	CEDAR 5'H	Solid	Cedar Backrails	Cedar Boards	#5 Style Picket Tops	Style 304		
6472-304	CEDAR 6'H	Solid	Cedar Backrails	Cedar Boards	#5 Style Picket Tops	Style 304		
8472-304	CEDAR 8'H	Solid	Cedar Backrails	Cedar Boards	#5 Style Picket Tops	Style 304		

**MATCHING GATES AVAILABLE**

**PLEASE NOTE: ONCE DELIVERED, EASTERN WOOD FENCE IS NON-REFUNDABLE.**

Wood fence is a natural product and natural weathering including splitting, warping, twisting, checking, raised grain, swelling, shrinkage, surface mold and/or mildew, fungi, or any other physical property of the wood including but not limited to knots can occur.

# SOLID PANELS - 202

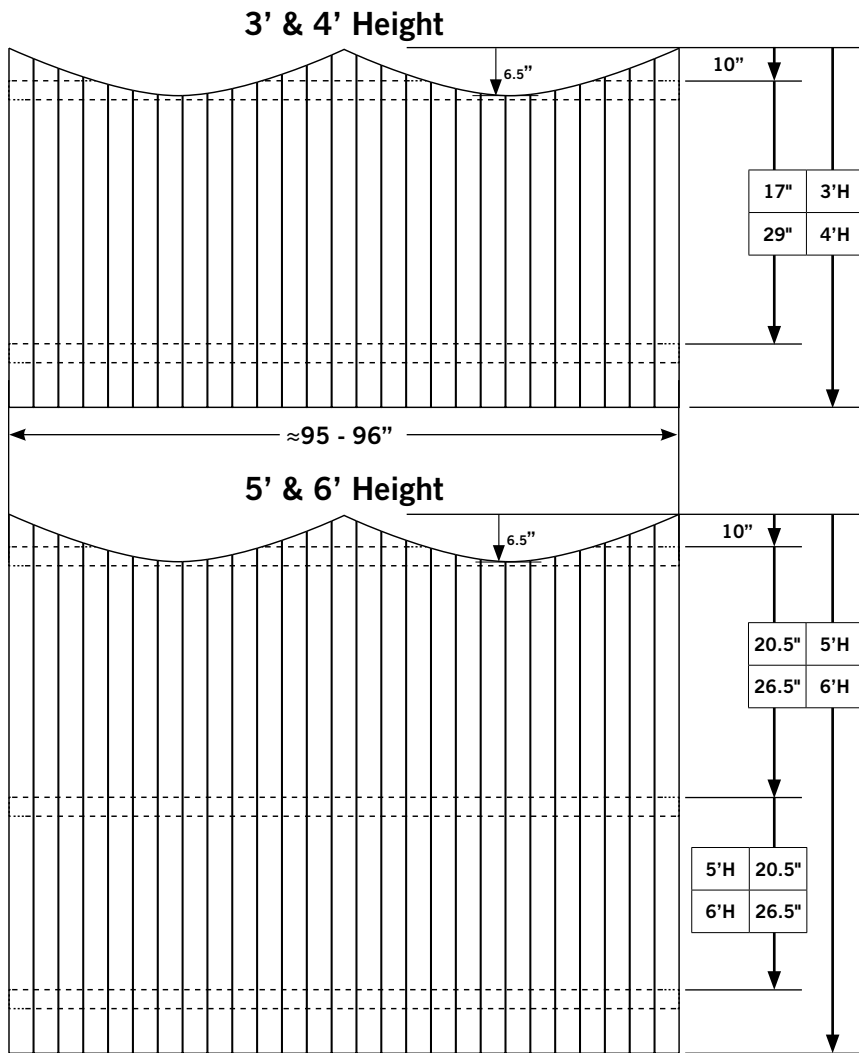

## 202 STYLE SOLID PANEL

3', 4', 5', 6' Height "Smooth Cut" Double Scalloped Cedar Solid Panels

BOARDS Nominal 1" x 4" / 27 Per Section

SPECIES White Cedar

NAILING TOP AND BOTTOM RAILS: Double Nailed  
MID-RAIL: End pickets are doubled nailed and the inside pickets are single nailed

NAILS Aluminum Spiral Nails

WIDTH 96" Nominal (Approx. 95" - 96")

RAILS STANDARD: 2" x 3" Nominal Cedar  
OPTIONAL: 2" x 3" Nominal Spruce  
OPTIONAL: Dowelled backrails - (Measurements may deviate from standard. Call for pricing and info)

GATES Matching gates available. Please CALL for more information

### PICKET TOP STYLES

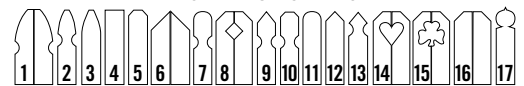

## SPRUCE BACKRAILS

Item #	Backrails	Description						Each
3462-202	SPRUCE 3'H	Solid	Spruce Backrails	Cedar Boards	#4 Style Picket Tops	Style 202		
4462-202	SPRUCE 4'H	Solid	Spruce Backrails	Cedar Boards	#4 Style Picket Tops	Style 202		
5462-202	SPRUCE 5'H	Solid	Spruce Backrails	Cedar Boards	#4 Style Picket Tops	Style 202		
6462-202	SPRUCE 6'H	Solid	Spruce Backrails	Cedar Boards	#4 Style Picket Tops	Style 202		
8462-202	SPRUCE 8'H	Solid	Spruce Backrails	Cedar Boards	#4 Style Picket Tops	Style 202		

## CEDAR BACKRAILS

Item #	Backrails	Description						Each
3472-202	CEDAR 3'H	Solid	Cedar Backrails	Cedar Boards	#4 Style Picket Tops	Style 202		
4472-202	CEDAR 4'H	Solid	Cedar Backrails	Cedar Boards	#4 Style Picket Tops	Style 202		
5472-202	CEDAR 5'H	Solid	Cedar Backrails	Cedar Boards	#4 Style Picket Tops	Style 202		
6472-202	CEDAR 6'H	Solid	Cedar Backrails	Cedar Boards	#4 Style Picket Tops	Style 202		
8472-202	CEDAR 8'H	Solid	Cedar Backrails	Cedar Boards	#4 Style Picket Tops	Style 202		

**MATCHING GATES AVAILABLE**

**PLEASE NOTE: ONCE DELIVERED, EASTERN WOOD FENCE IS NON-REFUNDABLE.**

Wood fence is a natural product and natural weathering including splitting, warping, twisting, checking, raised grain, swelling, shrinkage, surface mold and/or mildew, fungi, or any other physical property of the wood including but not limited to knots can occur.

# SOLID PANELS - 203

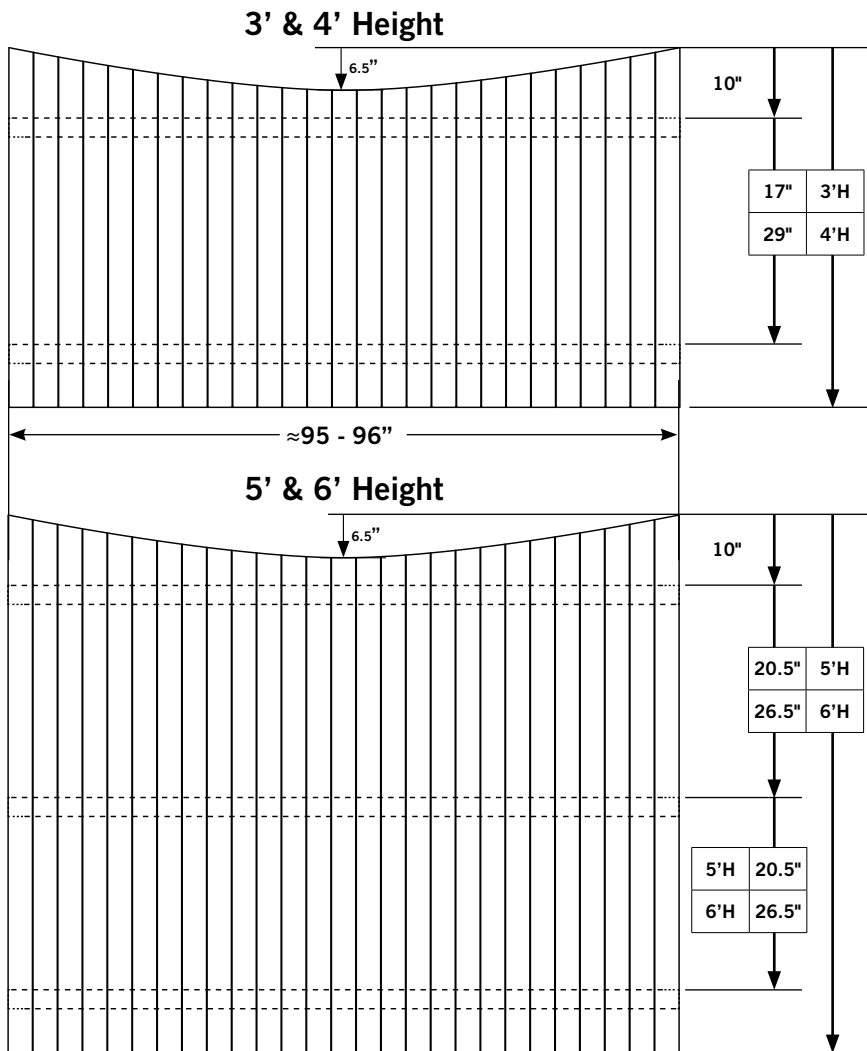

## 203 STYLE SOLID PANEL

3', 4', 5', 6' Height "Smooth Cut"

Scalloped Cedar Solid Panels

BOARDS Nominal 1" x 4" / 27 Per Section

SPECIES White Cedar

NAILING TOP AND BOTTOM RAILS: Double Nailed  
MID-RAIL: End pickets are doubled nailed and the inside pickets are single nailed

NAILS Aluminum Spiral Nails

WIDTH 96" Nominal (Approx. 95" - 96")

RAILS STANDARD: 2" x 3" Nominal Cedar  
OPTIONAL: 2" x 3" Nominal Spruce  
OPTIONAL: Dowelled backrails - (Measurements may deviate from standard. Call for pricing and info)

GATES Matching gates available. Please CALL for more information

### PICKET TOP STYLES

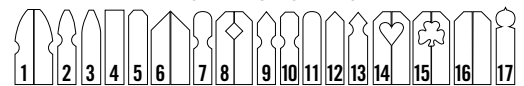

## SPRUCE BACKRAILS

Item #	Backrails	Description						Each
3462-203	SPRUCE 3'H	Solid	Spruce Backrails	Cedar Boards	#4 Style Picket Tops	Style 203		
4462-203	SPRUCE 4'H	Solid	Spruce Backrails	Cedar Boards	#4 Style Picket Tops	Style 203		
5462-203	SPRUCE 5'H	Solid	Spruce Backrails	Cedar Boards	#4 Style Picket Tops	Style 203		
6462-203	SPRUCE 6'H	Solid	Spruce Backrails	Cedar Boards	#4 Style Picket Tops	Style 203		
8462-203	SPRUCE 8'H	Solid	Spruce Backrails	Cedar Boards	#4 Style Picket Tops	Style 203		

## CEDAR BACKRAILS

Item #	Backrails	Description						Each
3472-203	CEDAR 3'H	Solid	Cedar Backrails	Cedar Boards	#4 Style Picket Tops	Style 203		
4472-203	CEDAR 4'H	Solid	Cedar Backrails	Cedar Boards	#4 Style Picket Tops	Style 203		
5472-203	CEDAR 5'H	Solid	Cedar Backrails	Cedar Boards	#4 Style Picket Tops	Style 203		
6472-203	CEDAR 6'H	Solid	Cedar Backrails	Cedar Boards	#4 Style Picket Tops	Style 203		
8472-203	CEDAR 8'H	Solid	Cedar Backrails	Cedar Boards	#4 Style Picket Tops	Style 203		

**MATCHING GATES AVAILABLE**

**PLEASE NOTE: ONCE DELIVERED, EASTERN WOOD FENCE IS NON-REFUNDABLE.**

Wood fence is a natural product and natural weathering including splitting, warping, twisting, checking, raised grain, swelling, shrinkage, surface mold and/or mildew, fungi, or any other physical property of the wood including but not limited to knots can occur.

# SOLID PANELS - 204

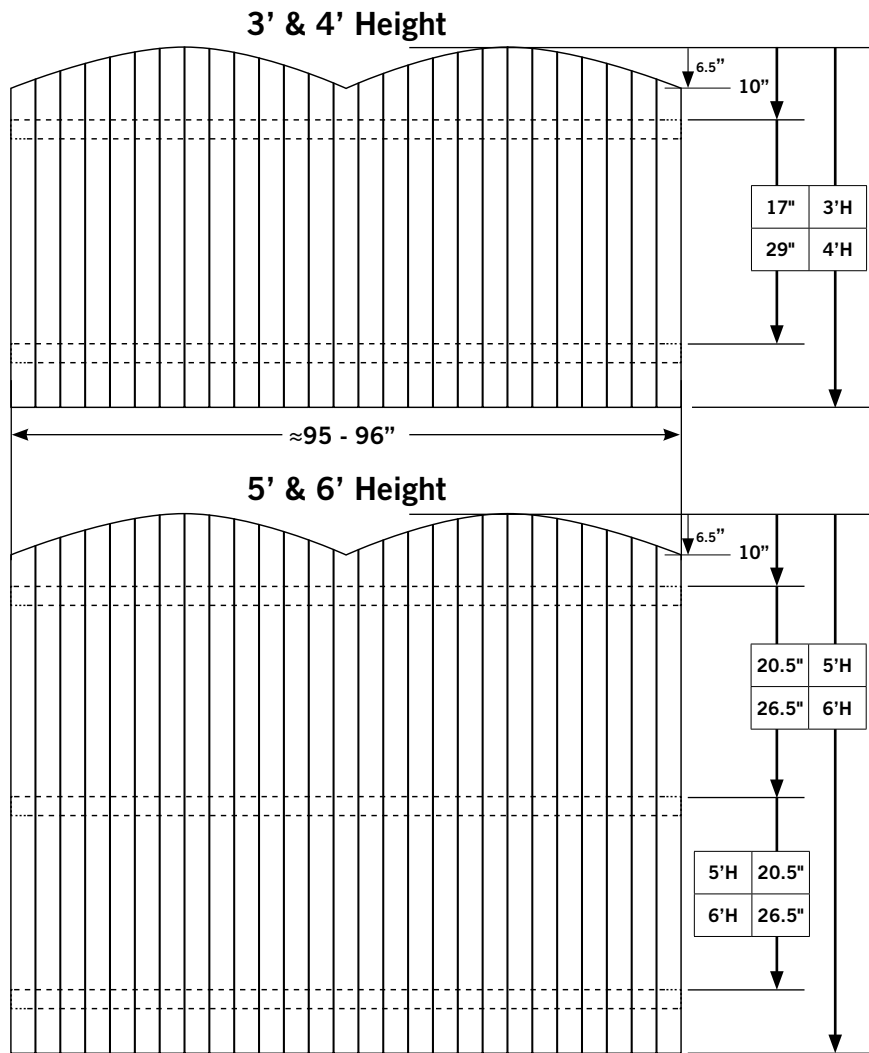

## 204 STYLE SOLID PANEL

3', 4', 5', 6' Height "Smooth Cut" Double Arched Cedar Solid Panels

BOARDS Nominal 1" x 4" / 27 Per Section

SPECIES White Cedar

NAILING TOP AND BOTTOM RAILS: Double Nailed  
MID-RAIL: End pickets are doubled nailed and the inside pickets are single nailed

NAILS Aluminum Spiral Nails

WIDTH 96" Nominal (Approx. 95" - 96")

RAILS STANDARD: 2" x 3" Nominal Cedar  
OPTIONAL: 2" x 3" Nominal Spruce  
OPTIONAL: Dowelled backrails - (Measurements may deviate from standard. Call for pricing and info)

GATES Matching gates available. Please CALL for more information

### PICKET TOP STYLES

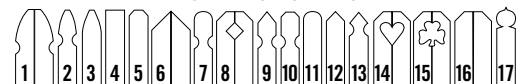

## SPRUCE BACKRAILS

Item #	Backrails	Description						Each
3462-204	SPRUCE 3'H	Solid	Spruce Backrails	Cedar Boards	#4 Style Picket Tops	Style 204		
4462-204	SPRUCE 4'H	Solid	Spruce Backrails	Cedar Boards	#4 Style Picket Tops	Style 204		
5462-204	SPRUCE 5'H	Solid	Spruce Backrails	Cedar Boards	#4 Style Picket Tops	Style 204		
6462-204	SPRUCE 6'H	Solid	Spruce Backrails	Cedar Boards	#4 Style Picket Tops	Style 204		
8462-204	SPRUCE 8'H	Solid	Spruce Backrails	Cedar Boards	#4 Style Picket Tops	Style 204		

## CEDAR BACKRAILS

Item #	Backrails	Description						Each
3472-204	CEDAR 3'H	Solid	Cedar Backrails	Cedar Boards	#4 Style Picket Tops	Style 204		
4472-204	CEDAR 4'H	Solid	Cedar Backrails	Cedar Boards	#4 Style Picket Tops	Style 204		
5472-204	CEDAR 5'H	Solid	Cedar Backrails	Cedar Boards	#4 Style Picket Tops	Style 204		
6472-204	CEDAR 6'H	Solid	Cedar Backrails	Cedar Boards	#4 Style Picket Tops	Style 204		
8472-204	CEDAR 8'H	Solid	Cedar Backrails	Cedar Boards	#4 Style Picket Tops	Style 204		

**MATCHING GATES AVAILABLE**

**PLEASE NOTE: ONCE DELIVERED, EASTERN WOOD FENCE IS NON-REFUNDABLE.**

Wood fence is a natural product and natural weathering including splitting, warping, twisting, checking, raised grain, swelling, shrinkage, surface mold and/or mildew, fungi, or any other physical property of the wood including but not limited to knots can occur.

# SOLID PANELS - 206

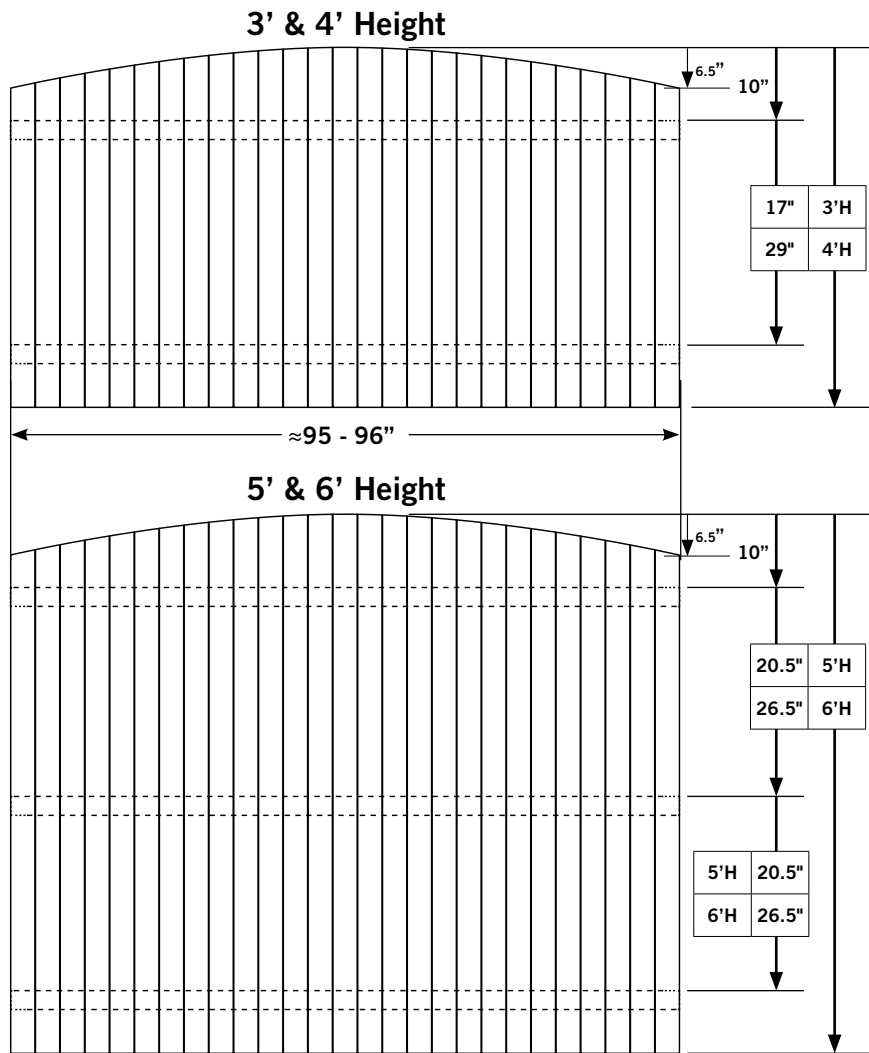

## 206 STYLE SOLID PANEL

3', 4', 5', 6' Height "Smooth Cut" Arched Cedar Solid Panels

BOARDS	Nominal 1" x 4" / 27 Per Section
SPECIES	White Cedar
NAILING	TOP AND BOTTOM RAILS: Double Nailed MID-RAIL: End pickets are doubled nailed and the inside pickets are single nailed
NAILS	Aluminum Spiral Nails
WIDTH	96" Nominal (Approx. 95" - 96")
RAILS	STANDARD: 2" x 3" Nominal Cedar OPTIONAL: 2" x 3" Nominal Spruce OPTIONAL: Dowelled backrails - (Measurements may deviate from standard. Call for pricing and info)
GATES	Matching gates available. Please CALL for more information

### PICKET TOP STYLES

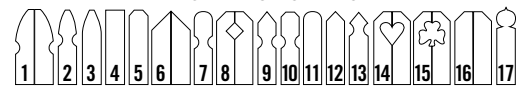

## SPRUCE BACKRAILS

Item #	Backrails	Description						Each
3462-206	SPRUCE 3'H	Solid	Spruce Backrails	Cedar Boards	#4 Style Picket Tops	Style 206		
4462-206	SPRUCE 4'H	Solid	Spruce Backrails	Cedar Boards	#4 Style Picket Tops	Style 206		
5462-206	SPRUCE 5'H	Solid	Spruce Backrails	Cedar Boards	#4 Style Picket Tops	Style 206		
6462-206	SPRUCE 6'H	Solid	Spruce Backrails	Cedar Boards	#4 Style Picket Tops	Style 206		
8462-206	SPRUCE 8'H	Solid	Spruce Backrails	Cedar Boards	#4 Style Picket Tops	Style 206		

## CEDAR BACKRAILS

Item #	Backrails	Description						Each
3472-206	CEDAR 3'H	Solid	Cedar Backrails	Cedar Boards	#4 Style Picket Tops	Style 206		
4472-206	CEDAR 4'H	Solid	Cedar Backrails	Cedar Boards	#4 Style Picket Tops	Style 206		
5472-206	CEDAR 5'H	Solid	Cedar Backrails	Cedar Boards	#4 Style Picket Tops	Style 206		
6472-206	CEDAR 6'H	Solid	Cedar Backrails	Cedar Boards	#4 Style Picket Tops	Style 206		
8472-206	CEDAR 8'H	Solid	Cedar Backrails	Cedar Boards	#4 Style Picket Tops	Style 206		

**MATCHING GATES AVAILABLE**

**PLEASE NOTE: ONCE DELIVERED, EASTERN WOOD FENCE IS NON-REFUNDABLE.**

Wood fence is a natural product and natural weathering including splitting, warping, twisting, checking, raised grain, swelling, shrinkage, surface mold and/or mildew, fungi, or any other physical property of the wood including but not limited to knots can occur.

# ONE PIECE TONGUE & GROOVE PANELS

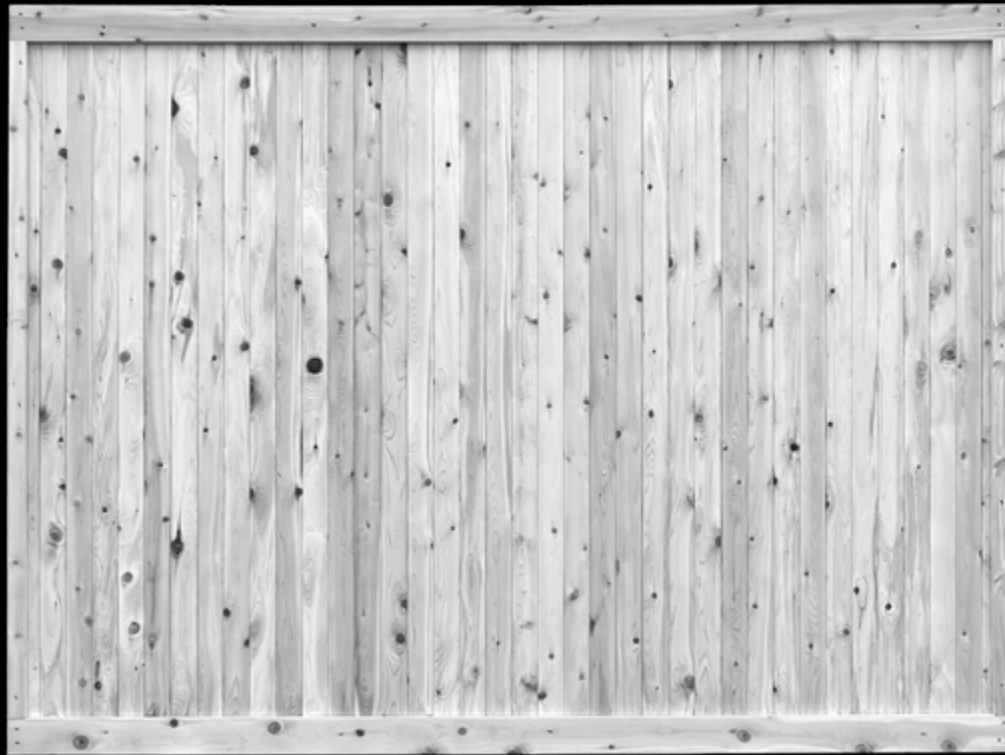

**#300**  
**Framed or Add Topper**  
(See Page F-54 For Different Toppers)



**#400W0**  
**One Piece w/o Diamond**



**#400**  
**One Piece Diamond**

# T & G ONE PIECE WITHOUT DIAMONDS

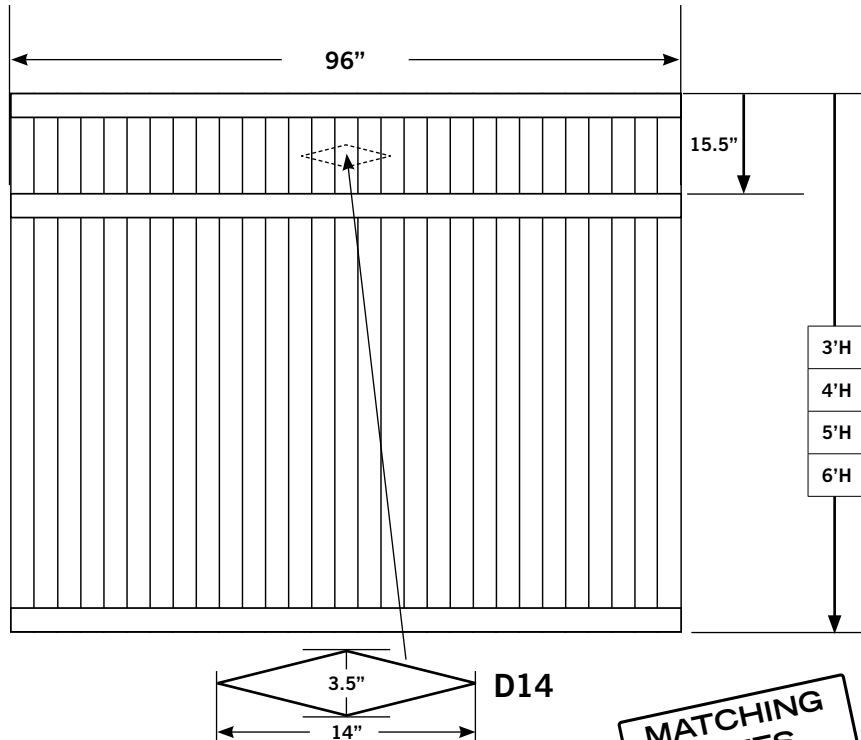

## 400WO TONGUE & GROOVE ONE PIECE W/O DIAMONDS 4', 5', 6', & 8' Height Cedar T&G Fence with Midrail (Custom Heights Available)

BOARDS	Nominal 1" x 4" / 29 Per Section
SPACING	None (Tongue & Groove)
	T & G BOTTOM VIEW 
SPECIES	STANDARD: White Cedar OPTIONAL: Red Cedar (Call for Pricing)
NAILING	Double Nailed
NAILS	Aluminum Spiral Nails
WIDTH	96" Exact
RAILS	STANDARD: Nominal 1" x 4" Cedar Boards
GATES	Matching gates available. Please CALL for more information

The 400WO style is often ordered with an optional cedar diamond (item #D14).  
(NOTE: D14 is ordered separately to be installed on-site.)

**MATCHING GATES AVAILABLE**

## 400WO STYLE ONE PIECE TONGUE AND GROOVE WITHOUT DIAMONDS

Item #	Description	Each
400WO-4*	Tongue and Groove   Cedar   4'H Style 400WO 3-Rail One Piece Tongue and Groove	<b>STOCKING ITEM</b>
400WO-5	Tongue and Groove   Cedar   5'H Style 400WO 3-Rail One Piece Tongue and Groove	
400WO-6*	Tongue and Groove   Cedar   6'H Style 400WO 3-Rail One Piece Tongue and Groove	<b>STOCKING ITEM</b>
400WO-8	Tongue and Groove   Cedar   8'H Style 400WO 3-Rail One Piece Tongue and Groove	
D14	14" Cedar Diamond Accent (Sold Separately)	

**PLEASE NOTE: ONCE DELIVERED, EASTERN WOOD FENCE IS NON-REFUNDABLE.**

Wood fence is a natural product and natural weathering including splitting, warping, twisting, checking, raised grain, swelling, shrinkage, surface mold and/or mildew, fungi, or any other physical property of the wood including but not limited to knots can occur.

# T & G ONE PIECE DIAMOND

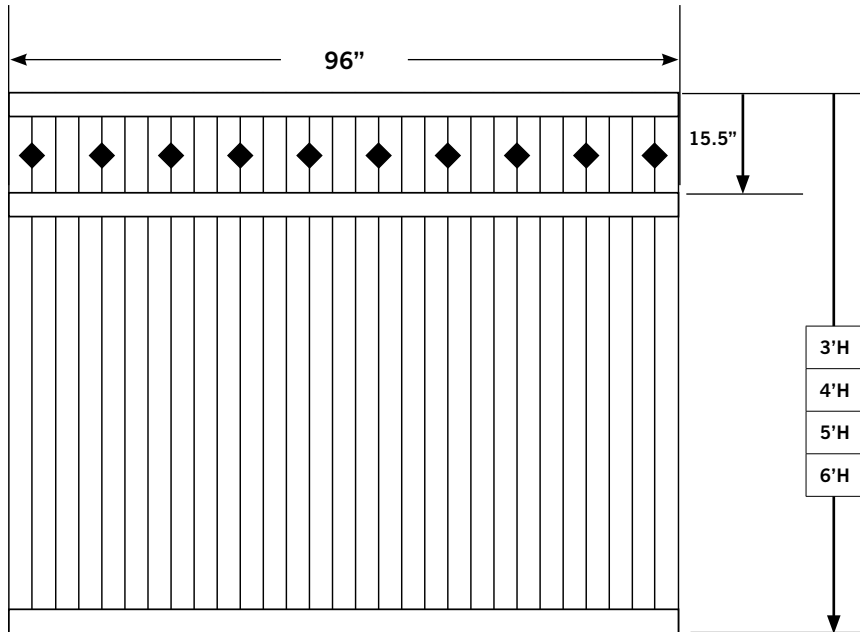

**MATCHING GATES AVAILABLE**

## 400 TONGUE & GROOVE ONE PIECE W/DIAMONDS

4', 5', 6', & 8' Height Cedar T&G Fence with Midrail and Diamond Cutouts

BOARDS Nominal 1" x 4" / 29 Per Section

SPACING None (Tongue & Groove)

T & G BOTTOM VIEW

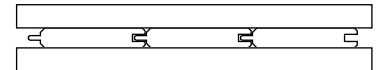

SPECIES STANDARD: White Cedar  
OPTIONAL: Red Cedar (Call for Pricing)

NAILING Double Nailed

NAILS Aluminum Spiral Nails

WIDTH 96" Exact

RAILS STANDARD: Nominal 1" x 4" Cedar Boards

GATES Matching gates available. Please CALL for more information

## 400WO STYLE ONE PIECE TONGUE AND GROOVE

Item #	Description	Each
400-4	Tongue and Groove   Cedar   4'H Style 400 3-Rail One Piece Tongue and Groove with Diamond Cutouts	
400-5	Tongue and Groove   Cedar   5'H Style 400 3-Rail One Piece Tongue and Groove with Diamond Cutouts	
400-6*	Tongue and Groove   Cedar   6'H Style 400 3-Rail One Piece Tongue and Groove with Diamond Cutouts	<b>STOCKING ITEM</b>
400-8	Tongue and Groove   Cedar   8'H Style 400 3-Rail One Piece Tongue and Groove with Diamond Cutouts	

**PLEASE NOTE: ONCE DELIVERED, EASTERN WOOD FENCE IS NON-REFUNDABLE.**

Wood fence is a natural product and natural weathering including splitting, warping, twisting, checking, raised grain, swelling, shrinkage, surface mold and/or mildew, fungi, or any other physical property of the wood including but not limited to knots can occur.

# T & G ONE PIECE FRAMED OR ADD TOPPER

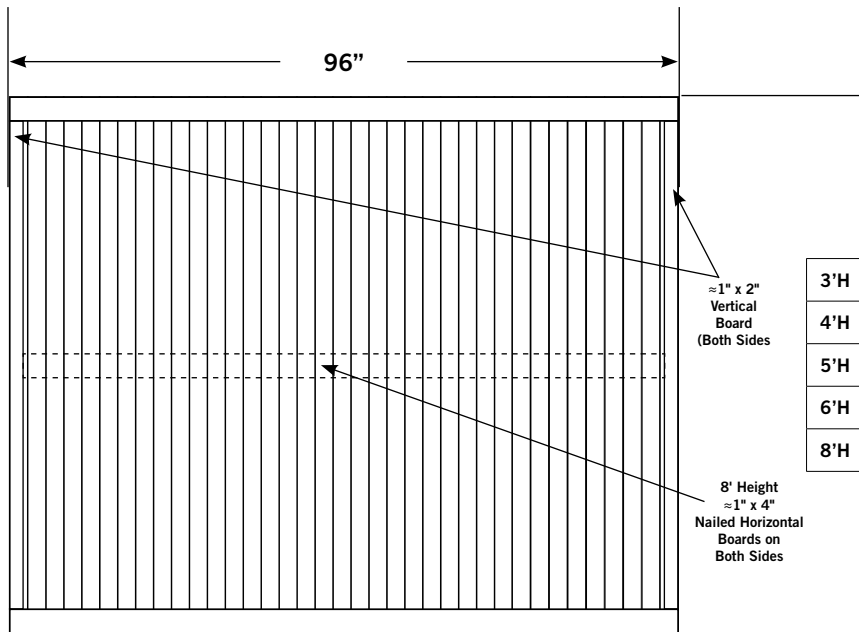

- 3'H
- 4'H
- 5'H
- 6'H
- 8'H

8' Height  
≈1" x 4"  
Nailed Horizontal  
Boards on  
Both Sides

## 300 TONGUE & GROOVE

3', 4', 5', 6', 8', Height Cedar T&G Fence

**BOARDS** Nominal 1" x 3" / 37 Per Section (Side Strips Included)

**SPACING** None (Tongue & Groove)

T & G BOTTOM VIEW

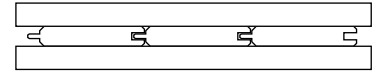

**SPECIES** STANDARD: White Cedar  
OPTIONAL: Red Cedar (Call for Pricing)

**NAILING** Double Nailed

**NAILS** Aluminum Spiral Nails

**WIDTH** 96" Exact

**RAILS** STANDARD: Nominal 1" x 4" Cedar Boards

**NOTE** 300 style T & G (only) comes with vertical 1" x 2" (nominal) boards on both sides



**GATES** Matching gates available. Please CALL for more information

**MATCHING GATES AVAILABLE**

CORNER

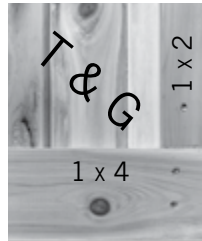

## 300 STYLE ONE PIECE TONGUE AND GROOVE

Item #	Description	Each
300-3	Tongue and Groove   Cedar   4'H Style 300 Framed with 1" x 2" (Nominal) Sides	
300-4*	Tongue and Groove   Cedar   4'H Style 300 Framed with 1" x 2" (Nominal) Sides	<b>STOCKING ITEM</b>
300-5*	Tongue and Groove   Cedar   5'H Style 300 Framed with 1" x 2" (Nominal) Sides	<b>STOCKING ITEM</b>
300-6*	Tongue and Groove   Cedar   6'H Style 300 Framed with 1" x 2" (Nominal) Sides (Includes 1" x 4" (Nominal) Removable Horizontal Board on One Side)	<b>STOCKING ITEM</b>
300-8	Tongue and Groove   Cedar   8'H Style 300 Framed with 1" x 2" (Nominal) Sides (Includes 1" x 4" (Nominal) Nailed Horizontal Boards on Both Sides)	

**PLEASE NOTE: ONCE DELIVERED, EASTERN WOOD FENCE IS NON-REFUNDABLE.**

Wood fence is a natural product and natural weathering including splitting, warping, twisting, checking, raised grain, swelling, shrinkage, surface mold and/or mildew, fungi, or any other physical property of the wood including but not limited to knots can occur.

# T & G WITH TOPPERS POPULAR STYLES



**#300-5 w/215-1  
T&G Base 5' and  
Diagonal Lattice Top 1'**



**#300-5 W/SQL18  
T&G Base 5' & Square  
Lattice Top 1'**



**#300-5 W/SQL18  
Both w/Top & Bottom Fascia Board**



## Suggested T & G Fence w/Topper Set-Up

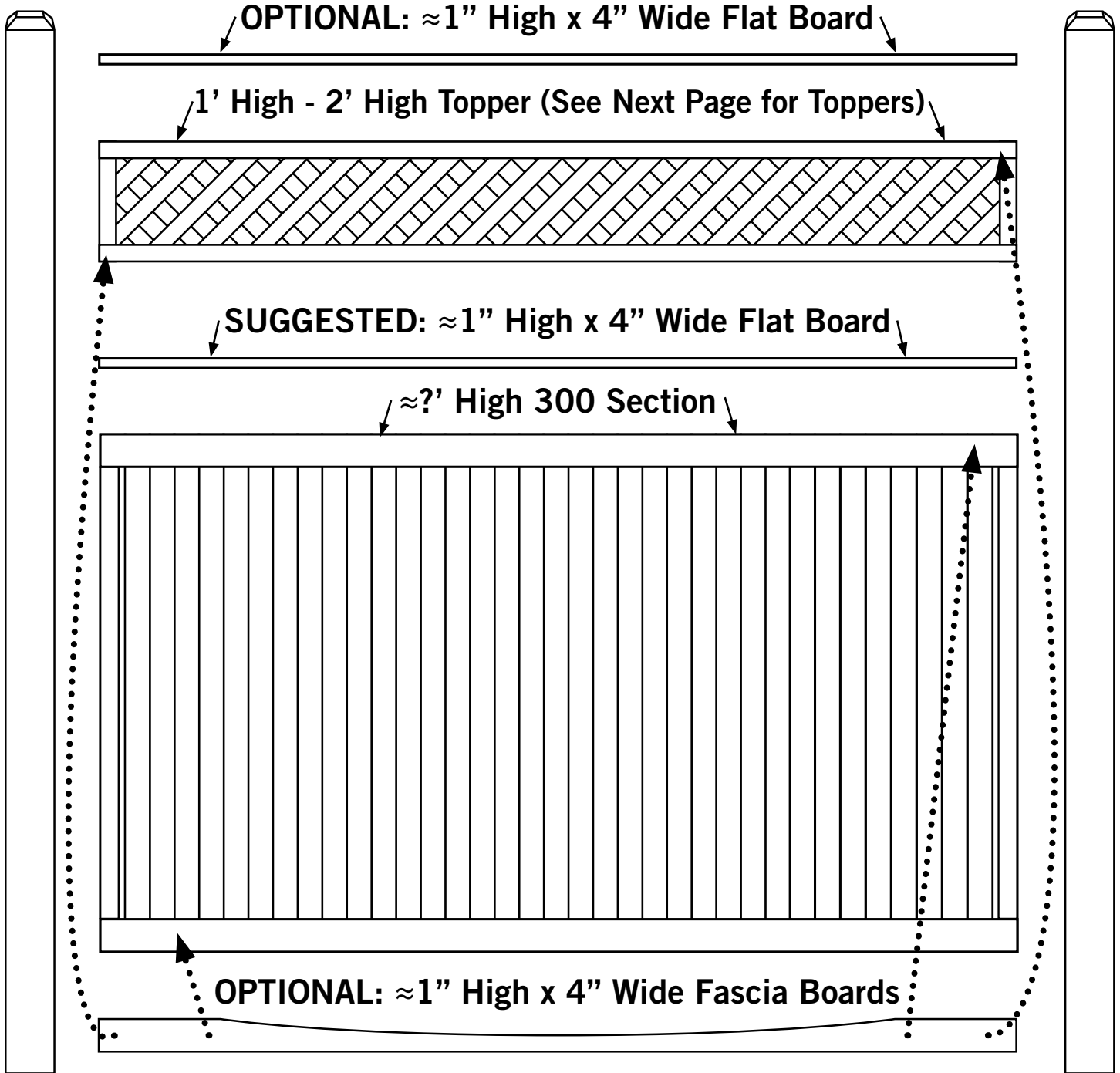

**PLEASE NOTE: ONCE DELIVERED, EASTERN WOOD FENCE IS NON-REFUNDABLE.**

Wood fence is a natural product and natural weathering including splitting, warping, twisting, checking, raised grain, swelling, shrinkage, surface mold and/or mildew, fungi, or any other physical property of the wood including but not limited to knots can occur.

# CUSTOM CEDAR TOPPERS



(All 96" Wide)

Item #

Each



700-1 (CLASSIC VICTORIAN)

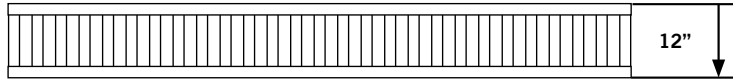
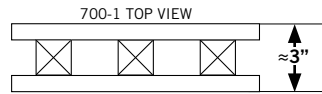

701-1 (CLASSIC VICTORIAN FRAMED)

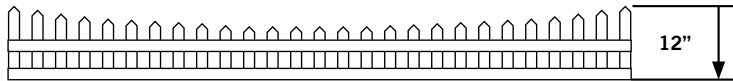
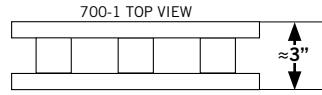

707-1 (CLASSIC VICTORIAN SCALLOPED)

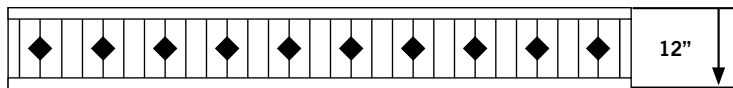
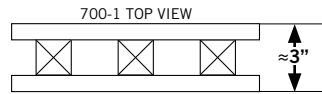

400-1 (DIAMOND)

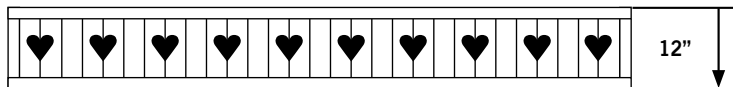
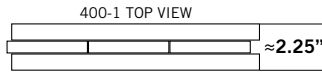

400H-1 (HEARTS)

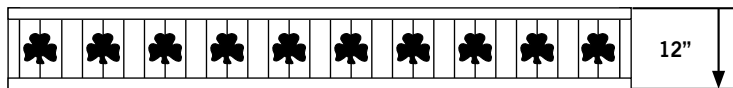
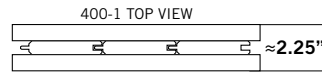

400S-1 (SHAMROCK)

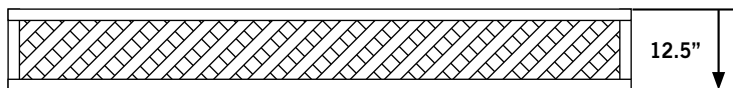
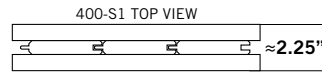

215-1\* (DIAGONAL)

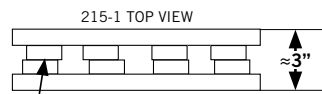

Diagonal Boards Have Random Alignments

STOCKING ITEM

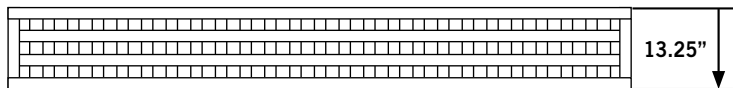

SQL18\* (SQUARE LATTICE)

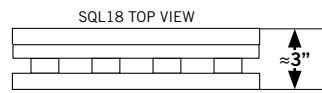

STOCKING ITEM



OT-1 (RINGS)

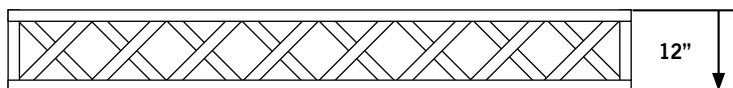
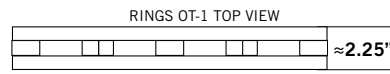

800-1 (CRISS CROSS)



**PLEASE NOTE: ONCE DELIVERED, EASTERN WOOD FENCE IS NON-REFUNDABLE.**

Wood fence is a natural product and natural weathering including splitting, warping, twisting, checking, raised grain, swelling, shrinkage, surface mold and/or mildew, fungi, or any other physical property of the wood including but not limited to knots can occur.

# T & G CREATE YOUR OWN 300 STYLE T & G w/TOPPER

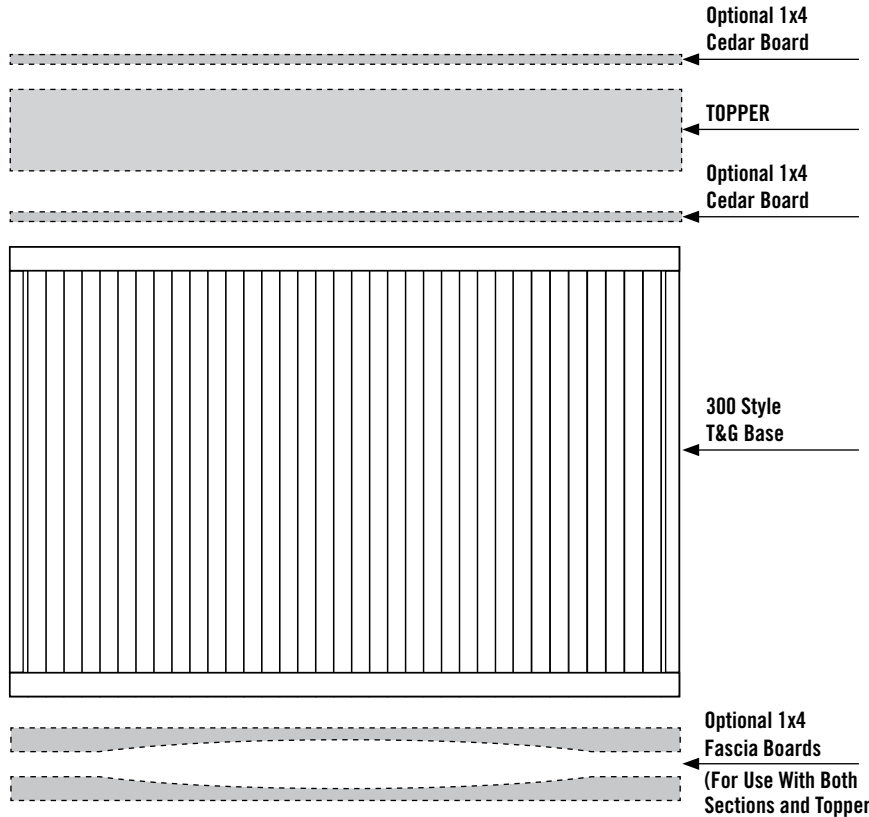

## CREATE YOUR OWN 300 STYLE TONGUE & GROOVE SECTION WITH TOPPER

- NOTES
1. Order your 300 style base (comes fully assembled)
  2. Order the topper you're looking for (comes fully assembled)
  3. Order an optional 1x4 cedar board (CD148) BETWEEN the base and the topper (add onsite)
  4. Order an optional 1x4 cedar board (CD148) for ON TOP of the topper (add onsite)
  5. Order optional fascia boards (FASCIA1X4). (IMPORTANT! Fascia boards can be ordered individually or added during the manufacturing process (additional charges may apply). When requesting fascia boards for any section or topper, you must specify the quantity and location (TOP/BOTTOM, FRONT/BACK) at the time of your order.)

**TO CREATE THIS SECTION, THE BASE, TOPPER, FASCIA, and OPTIONAL CEDAR BOARDS ARE ALL SOLD SEPARATELY**

### 300 STYLE BASE

Item #	Description	Each
300-3	Tongue and Groove Cedar   Style 300 in 3'H	
300-4*	Tongue and Groove Cedar   Style 300 in 4'H	STOCKING ITEM
300-5*	Tongue and Groove Cedar   Style 300 in 5'H	STOCKING ITEM

### TOPPER

Item #	Description	Each
700-1	12" Height Classic Victorian Picket Topper	
701-1	12" Height Framed Classic Victorian Picket Topper	
707-1	12" Height Scalloped Classic Victorian Picket Topper	
400-1	12" Height Diamond Tongue and Groove Topper	
400H-1	12" Height Heart Tongue and Groove Topper	
400S-1	12" Height Shamrock Tongue and Groove Topper	
215-1*	12.5" Height Diagonal Lattice Topper	STOCKING ITEM
SQL18*	13.25" Height Square Lattice Topper	
OT-1	13.5" Height Rings Topper	
800-1	12" Height Criss-Cross Style Topper	

### ADDITIONAL OPTIONS

Item #	Description	Each
CD148	1 x 4 x 8 Cedar Board #1	
FASCIA1X4	1 x 4 x 8 Cedar FASCIA Board #1 (IMPORTANT! Fascia boards can be ordered individually or added during the manufacturing process (additional charges may apply). When requesting fascia boards for any section or topper, you must specify the quantity and location (TOP/BOTTOM, FRONT/BACK) at the time of your order.)	

**PLEASE NOTE: ONCE DELIVERED, EASTERN WOOD FENCE IS NON-REFUNDABLE.** Wood fence is a natural product and natural weathering including splitting, warping, twisting, checking, raised grain, swelling, shrinkage, surface mold and/or mildew, fungi, or any other physical property of the wood including but not limited to knots can occur.

# T & G T&G BASE and DIAGONAL LATTICE TOPPER

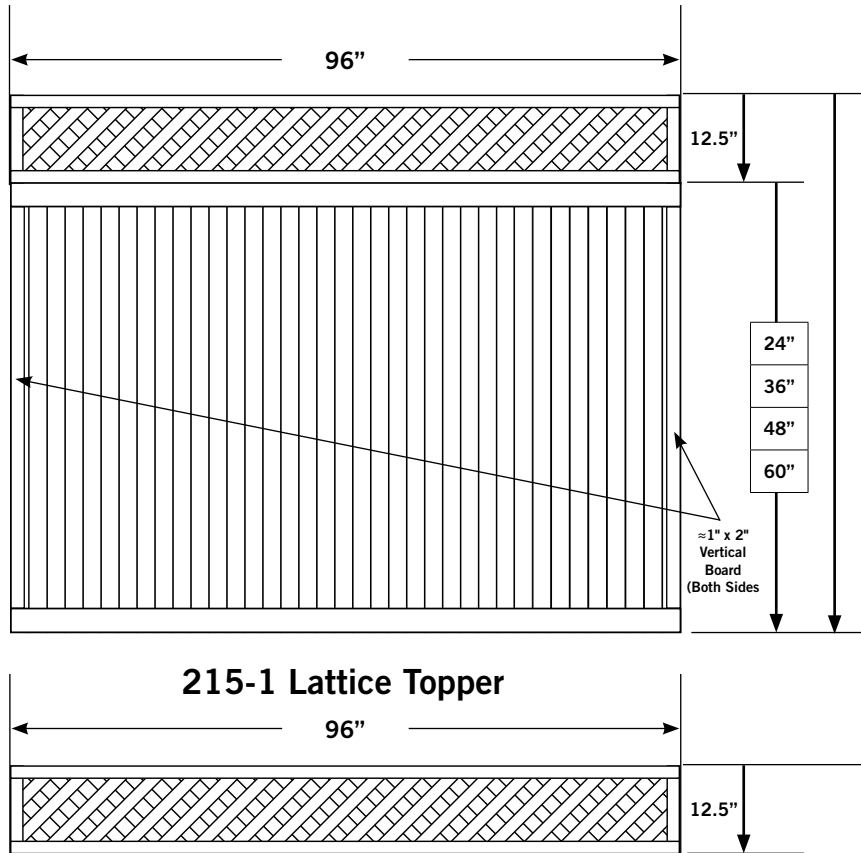

## 300 TONGUE & GROOVE WITH 215-1 TOPPER

3', 4', 5' Height Cedar T&G Fence with 215-1 Diagonal Lattice Topper

**BOARDS** Nominal 1" x 4" / 30 Per Section (Side Strips Included)

**SPACING** None (Tongue & Groove)

T & G BOTTOM VIEW

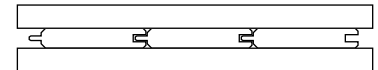

**SPECIES** STANDARD: White Cedar  
OPTIONAL: Red Cedar (Call for Pricing)

**NAILING** Double Nailed

**NAILS** Aluminum Spiral Nails

**WIDTH** 96" Exact

**RAILS** STANDARD: Nominal 1" x 4" Cedar Boards

### 215-1 Lattice Topper

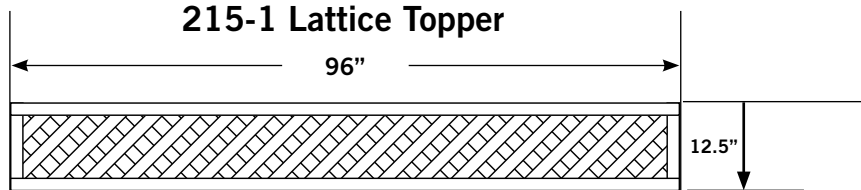

Eastern 215-1 Wood Fence Toppers are made sturdy and strong out of thick 2"x 2" (nominal) crossmembers nailed together by 1" x 3" (nominal) boards. (See lattice top view.)

Diagonal Boards Have Random Alignments

LATTICE TOP VIEW

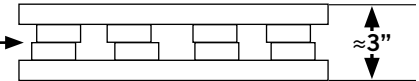

**TO CREATE THIS SECTION, THE BASE, TOPPER, and OPTIONAL CEDAR BOARDS ARE ALL SOLD SEPARATELY**

### 300 STYLE BASE

Item #	Description	Each
300-3	Tongue and Groove   Cedar   Style 300 in 3'H	
300-4*	Tongue and Groove   Cedar   Style 300 in 4'H	<b>STOCKING ITEM</b>
300-5*	Tongue and Groove   Cedar   Style 300 in 5'H	<b>STOCKING ITEM</b>

### 215-1 TOPPER

Item #	Description	Each
215-1*	≈1' Height 215 Style Lattice Topper	<b>STOCKING ITEM</b>

### ADDITIONAL OPTIONS

Item #	Description	Each
CD148	1 x 4 x 8 Cedar Board #1	
FASCIA1X4	1 x 4 x 8 Cedar FASCIA Board #1 (IMPORTANT! Fascia boards can be ordered individually or added during the manufacturing process (additional charges may apply). When requesting fascia boards for any section or topper, you must specify the quantity and location (TOP/BOTTOM, FRONT/BACK) at the time of your order.)	

**PLEASE NOTE: ONCE DELIVERED, EASTERN WOOD FENCE IS NON-REFUNDABLE.** Wood fence is a natural product and natural weathering including splitting, warping, twisting, checking, raised grain, swelling, shrinkage, surface mold and/or mildew, fungi, or any other physical property of the wood including but not limited to knots can occur.

# T & G T&G BASE and SQUARE LATTICE TOPPER

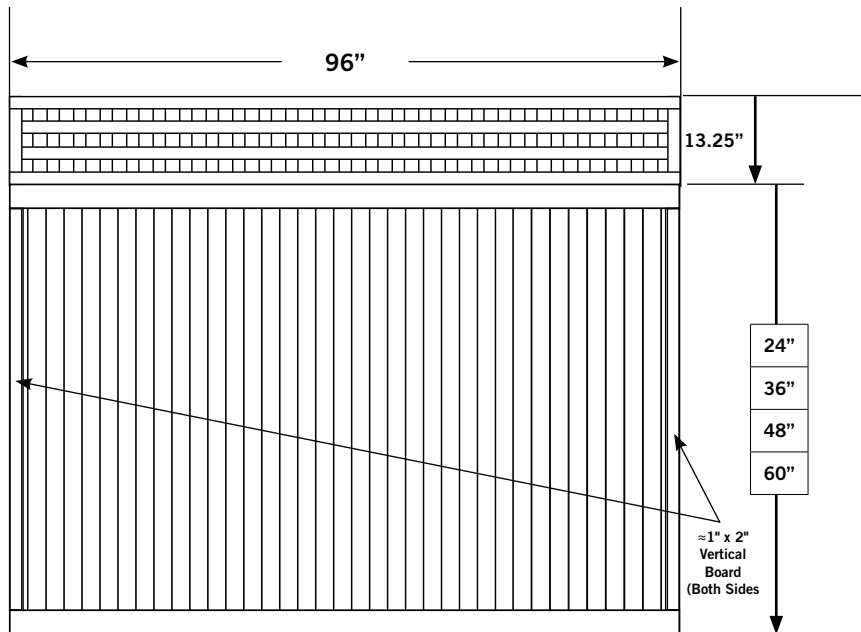

## 300 TONGUE & GROOVE WITH SQL18 TOPPER

3', 4', 5' Height Cedar T&G Fence with SQL18 Square Lattice Topper

BOARDS Nominal 1" x 4" / 30 Per Section (Side Strips Included)

SPACING None (Tongue & Groove)

T & G BOTTOM VIEW

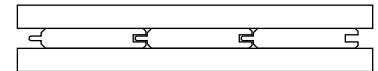

SPECIES STANDARD: White Cedar  
OPTIONAL: Red Cedar (Call for Pricing)

NAILING Double Nailed

NAILS Aluminum Spiral Nails

WIDTH 96" Exact

RAILS STANDARD: Nominal 1" x 4" Cedar Boards

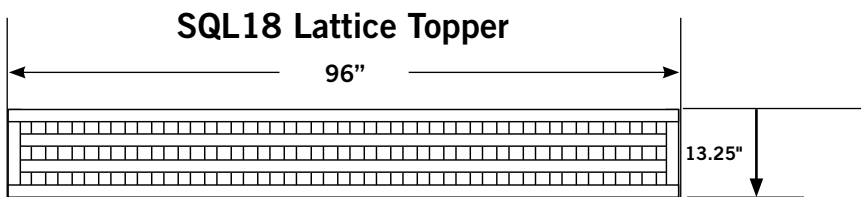

Eastern SQL18 Wood Fence Toppers are made sturdy and strong out of thick 2"x 2" (nominal) cross-members nailed together by 1" x 3" (nominal) boards. (See lattice top view.)

LATTICE TOP VIEW

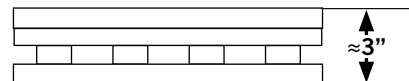

**TO CREATE THIS SECTION, THE BASE, TOPPER, and OPTIONAL CEDAR BOARDS ARE ALL SOLD SEPARATELY**

### 300 STYLE BASE

Item #	Description	Each
300-3	Tongue and Groove   Cedar   Style 300 in 3'H	
300-4*	Tongue and Groove   Cedar   Style 300 in 4'H	STOCKING ITEM
300-5*	Tongue and Groove   Cedar   Style 300 in 5'H	STOCKING ITEM

### 215-1 TOPPER

Item #	Description	Each
SQL18*	≈1' Height 215 Style Lattice Topper	STOCKING ITEM

### ADDITIONAL OPTIONS

Item #	Description	Each
CD148	1 x 4 x 8 Cedar Board #1	
FASCIA1X4	1 x 4 x 8 Cedar FASCIA Board #1 (IMPORTANT! Fascia boards can be ordered individually or added during the manufacturing process (additional charges may apply). When requesting fascia boards for any section or topper, you must specify the quantity and location (TOP/BOTTOM, FRONT/BACK) at the time of your order.)	

**PLEASE NOTE: ONCE DELIVERED, EASTERN WOOD FENCE IS NON-REFUNDABLE.** Wood fence is a natural product and natural weathering including splitting, warping, twisting, checking, raised grain, swelling, shrinkage, surface mold and/or mildew, fungi, or any other physical property of the wood including but not limited to knots can occur.

# T & G T&G BASE and SQ. LAT. TOPPER w/TOP & BOTTOM FASCIA BOARDS

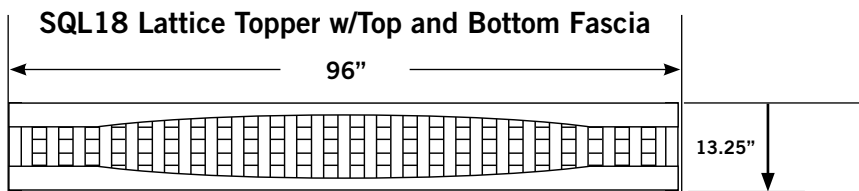
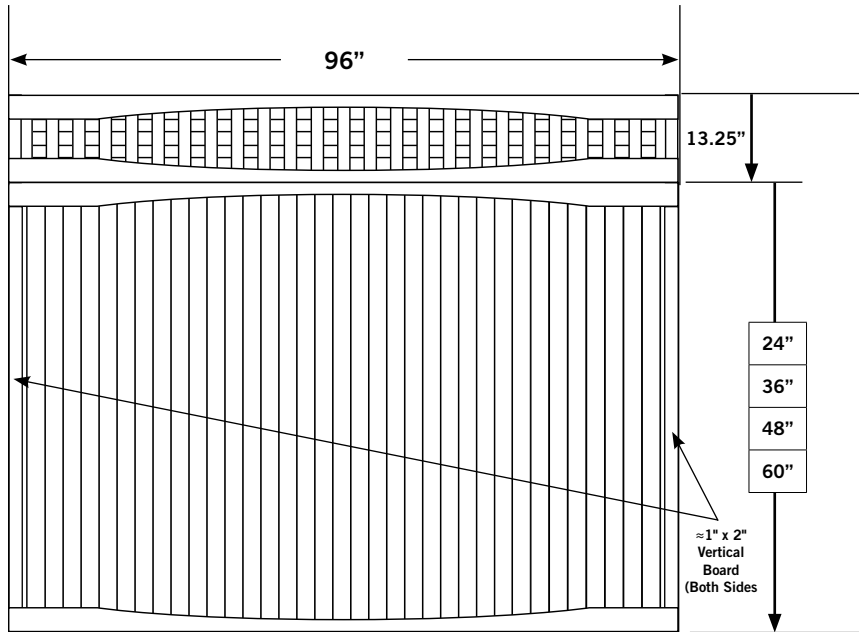

Eastern SQL18 Wood Fence Toppers are made sturdy and strong out of thick 2"x 2" (nominal) crossmembers nailed together by 1" x 3" (nominal) boards. (See lattice top view.)

**NOTE:** Fascia boards are added to topper as an option.

## 300 TONGUE & GROOVE WITH SQL18 TOPPER w/TOP & BOTTOM FASCIA BOARDS

3', 4', 5' Height Cedar T&G Fence with Top and Bottom Fascia Boards and a SQL18 Square Lattice Topper with Top and Bottom Fascia Boards

**BOARDS** Nominal 1" x 4" / 30 Per Section (Side Strips Included)

**SPACING** None (Tongue & Groove)

T & G BOTTOM VIEW

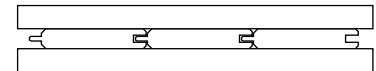

**SPECIES** STANDARD: White Cedar  
OPTIONAL: Red Cedar (Call for Pricing)

**NAILING** Double Nailed

**NAILS** Aluminum Spiral Nails

**WIDTH** 96" Exact

**RAILS** STANDARD: Nominal 1" x 4" Cedar Boards

**NOTES** IMPORTANT! Fascia boards can be ordered individually or added during the manufacturing process (additional charges may apply). When requesting fascia boards for any section or topper, you must specify the quantity and location (TOP/BOTTOM, FRONT/BACK) at the time of your order.

## TO CREATE THIS SECTION, THE BASE, TOPPER, FASCIA, and OPTIONAL CEDAR BOARDS ARE ALL SOLD SEPARATELY

### 300 STYLE BASE WITH ADDED FASCIA BOARDS

Item #	Description	Each
300-3	Tongue and Groove   Cedar   Style 300 in 3'H	
300-4*	Tongue and Groove   Cedar   Style 300 in 4'H	STOCKING ITEM
300-5*	Tongue and Groove   Cedar   Style 300 in 5'H	STOCKING ITEM
FASCIA1X4	1 x 4 x 8 Cedar FASCIA Board #1 (Priced Individually. This section has 2 front and 2 back fascia boards)	

### SQL-18 TOPPER WITH ADDED FASCIA BOARDS

Item #	Description	Each
215-1*	≈1' Height 215 Style Lattice Topper	STOCKING ITEM
FASCIA1X4	1 x 4 x 8 Cedar FASCIA Board #1 (Priced Individually. This section has 2 front and 2 back fascia boards)	

### ADDITIONAL OPTIONS

Item #	Description	Each
CD148	1 x 4 x 8 Cedar Board #1	
FASCIA1X4	1 x 4 x 8 Cedar FASCIA Board #1 (IMPORTANT! Fascia boards can be ordered individually or added during the manufacturing process (additional charges may apply). When requesting fascia boards for any section or topper, you must specify the quantity and location (TOP/BOTTOM, FRONT/BACK) at the time of your order.)	

**PLEASE NOTE: ONCE DELIVERED, EASTERN WOOD FENCE IS NON-REFUNDABLE.** Wood fence is a natural product and natural weathering including splitting, warping, twisting, checking, raised grain, swelling, shrinkage, surface mold and/or mildew, fungi, or any other physical property of the wood including but not limited to knots can occur.

# CLASSIC VICTORIAN PICKET POPULAR STYLES



## RED CEDAR CLASSIC VICTORIAN PICKET

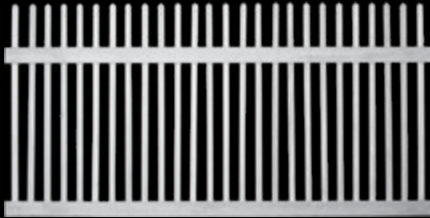

**700**  
STRAIGHT

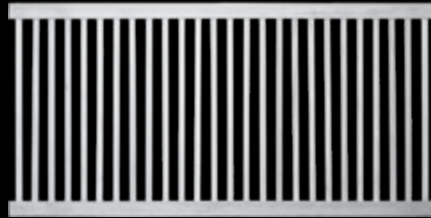

**701**  
2- RAIL FRAMED



**702**  
2-RAIL STAGGERED

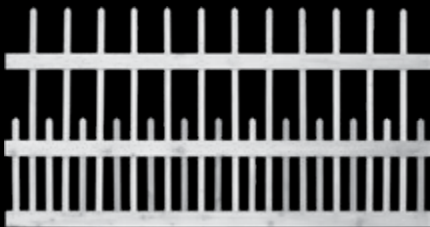

**703**  
3-RAIL STAGGERED



**705**  
2-RAIL STAGGERED



**706**  
STEP DOWN



**707**  
SCALLOPED

### GATES

Item #	Price Each
CWG700-	42W x 48H
CDG700-	60W x 48H

### CWG-700 WALK GATE



# CLAS. VIC. PICKET 700 STYLE - STRAIGHT



## 700 STYLE CLASSIC VICTORIAN PICKET

3', 4', and 5' Height Straight Top Red Cedar Spaced Picket Fence

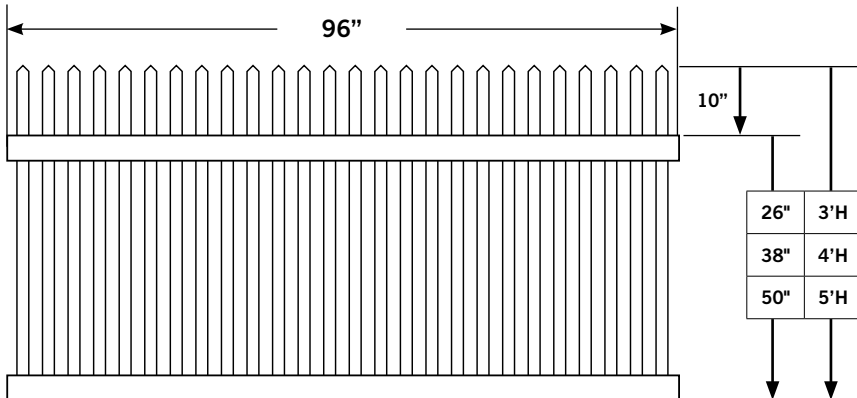

PICKETS	Nominal 2" x 2" / 26 Per Section
SPACING	STANDARD: Nominal Between 2" and 2-1/4"
	OPTIONAL: Other spacing available. Example: 1-3/4", 1-7/8", etc.
SPECIES	Red Cedar
NAILING	Single Nailed
NAILS	Aluminum Spiral Nails
WIDTH	96" Actual
RAILS	STANDARD: All Rails 1" x 4" x 8" Red Cedar (Nominal)
	OPTIONAL: Bottom Rails 1" x 6" x 8" Red Cedar (Nominal) (Add \$ per side)
TABS	NONE
OPTIONAL	Rail Edging (← See styles and pricing)
GATES	Matching gates available. Please CALL for more information

RAIL EDGING STYLES (PRICED PER CORNER)					
\$ ←  → \$					
BASIC	A	B	C	D	E
\$	Add \$ Ea.	Add \$ Ea.	Add \$ Ea.	Add \$ Ea.	Add \$ Ea.

## 700 STYLE STRAIGHT TOP WESTERN RED CEDAR CLASSIC VICTORIAN PICKET

Item #	Board Rail Style	Description	Each
700-3	SEE ABOVE	3'H   Spaced   Western Red Cedar Pickets   Pointed Victorian Tops   Style 700   Straight Top	
700-4	SEE ABOVE	4'H   Spaced   Western Red Cedar Pickets   Pointed Victorian Tops   Style 700   Straight Top	
700-5	SEE ABOVE	5'H   Spaced   Western Red Cedar Pickets   Pointed Victorian Tops   Style 700   Straight Top	
700-6	SEE ABOVE	6'H   Spaced   Western Red Cedar Pickets   Pointed Victorian Tops   Style 700   Straight Top	

**MATCHING GATES AVAILABLE**

**PLEASE NOTE: ONCE DELIVERED, EASTERN WOOD FENCE IS NON-REFUNDABLE.**

Wood fence is a natural product and natural weathering including splitting, warping, twisting, checking, raised grain, swelling, shrinkage, surface mold and/or mildew, fungi, or any other physical property of the wood including but not limited to knots can occur.

# CLAS. VIC. PICKET 701 STYLE - FRAMED



## 701 STYLE CLASSIC VICTORIAN PICKET

3', 4', and 5' Height Framed Style Red Cedar Spaced Picket Fence

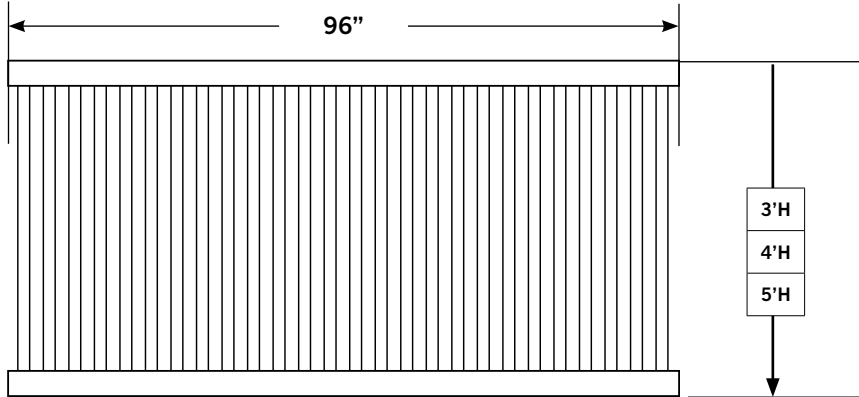

PICKETS	Nominal 2" x 2" / 26 Per Section
SPACING	STANDARD: Nominal Between 2" and 2-1/4" OPTIONAL: Other spacing available. Example: 1-3/4", 1-7/8", etc.
SPECIES	Red Cedar
NAILING	Single Nailed
NAILS	Aluminum Spiral Nails
WIDTH	96" Actual
RAILS	STANDARD: All Rails 1" x 4" x 8" Red Cedar (Nominal) OPTIONAL: Bottom Rails 1" x 6" x 8" Red Cedar (Nominal) (Add \$ per side)
TABS	NONE
OPTIONAL	Rail Edging (← See styles and pricing)
GATES	Matching gates available. Please CALL for more information

RAIL EDGING STYLES (PRICED PER CORNER)					
\$ ←  → \$					
BASIC	A	B	C	D	E
\$	Add \$ Ea.	Add \$ Ea.	Add \$ Ea.	Add \$ Ea.	Add \$ Ea.

## 701 STYLE FRAMED WESTERN RED CEDAR CLASSIC VICTORIAN PICKET

Item #	Board Rail Style	Description	Each
701-3	SEE ABOVE	3'H   Spaced   Western Red Cedar Pickets   Framed Top Rail   Style 701	
701-4	SEE ABOVE	4'H   Spaced   Western Red Cedar Pickets   Framed Top Rail   Style 701	
701-5	SEE ABOVE	5'H   Spaced   Western Red Cedar Pickets   Framed Top Rail   Style 701	
701-6	SEE ABOVE	6'H   Spaced   Western Red Cedar Pickets   Framed Top Rail   Style 701	

**MATCHING GATES AVAILABLE**

**PLEASE NOTE: ONCE DELIVERED, EASTERN WOOD FENCE IS NON-REFUNDABLE.**

Wood fence is a natural product and natural weathering including splitting, warping, twisting, checking, raised grain, swelling, shrinkage, surface mold and/or mildew, fungi, or any other physical property of the wood including but not limited to knots can occur.

# CLAS. VIC. PICK. 702 2-RAIL STAGGERED



## 702 STYLE CLASSIC VICTORIAN PICKET

3', 4', and 5' Height 2-Rail Staggered Red Cedar Spaced Picket Fence

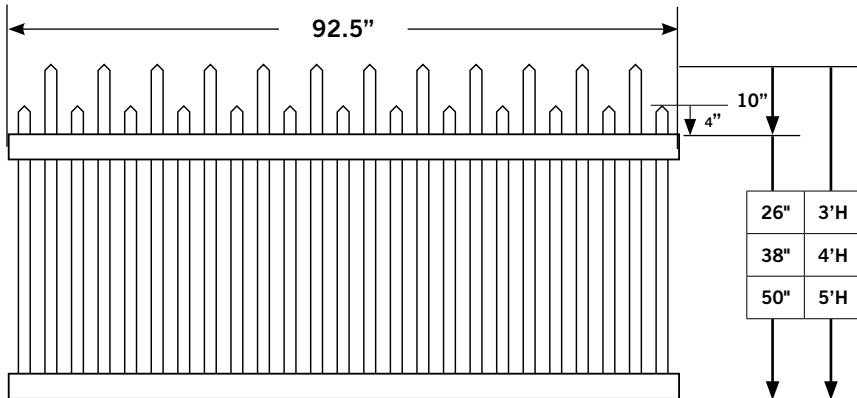

PICKETS	Nominal 2" x 2" / 25 Per Section
SPACING	STANDARD: Nominal Between 2" and 2-1/4"
	OPTIONAL: Other spacing available. Example: 1-3/4", 1-7/8", etc.
SPECIES	Red Cedar
NAILING	Single Nailed
NAILS	Aluminum Spiral Nails
WIDTH	92.5" Actual
RAILS	STANDARD: All Rails 1" x 4" x 8" Red Cedar (Nominal)
	OPTIONAL: Bottom Rails 1" x 6" x 8" Red Cedar (Nominal) (Add \$ per side)
TABS	NONE
OPTIONAL	Rail Edging (← See styles and pricing)
GATES	Matching gates available. Please CALL for more information

RAIL EDGING STYLES (PRICED PER CORNER)					
\$ ←  → \$					
BASIC	A	B	C	D	E
\$	Add \$ Ea.	Add \$ Ea.	Add \$ Ea.	Add \$ Ea.	Add \$ Ea.

## 702 STYLE 2-RAIL STAGGERED WESTERN RED CEDAR CLASSIC VICTORIAN PICKET

Item #	Board Rail Style	Description	Each
702-3	SEE ABOVE	3'H   Spaced   Western Red Cedar Pickets   Pointed Victorian Tops   Style 702   Straight Top	
702-4	SEE ABOVE	4'H   Spaced   Western Red Cedar Pickets   Pointed Victorian Tops   Style 702   Straight Top	
702-5	SEE ABOVE	5'H   Spaced   Western Red Cedar Pickets   Pointed Victorian Tops   Style 702   Straight Top	
702-6	SEE ABOVE	6'H   Spaced   Western Red Cedar Pickets   Pointed Victorian Tops   Style 702   Straight Top	

**MATCHING GATES AVAILABLE**

**PLEASE NOTE: ONCE DELIVERED, EASTERN WOOD FENCE IS NON-REFUNDABLE.**

Wood fence is a natural product and natural weathering including splitting, warping, twisting, checking, raised grain, swelling, shrinkage, surface mold and/or mildew, fungi, or any other physical property of the wood including but not limited to knots can occur.

# CLAS. VIC. PICK. 703 STYLE - 3-RAIL STAGGERED



## 703 STYLE CLASSIC VICTORIAN PICKET

3', 4', and 5' Height Staggered Red Cedar Spaced Picket Fence

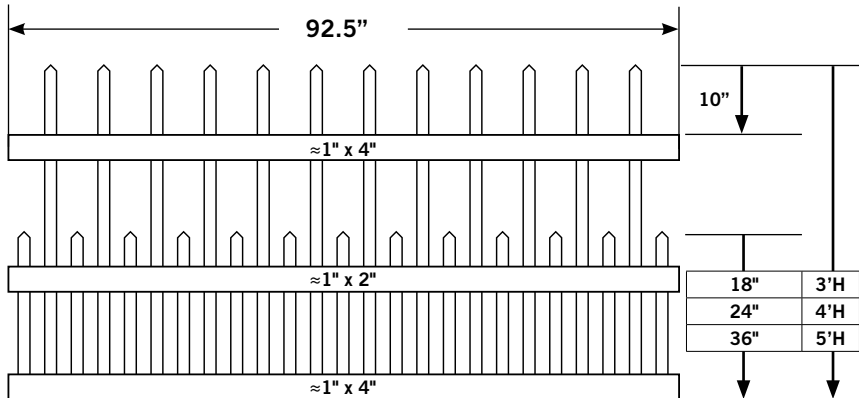

PICKETS	Nominal 2" x 2" / 25 Per Section
SPACING	Nominal Between 2" and 2-1/4"
SPECIES	Red Cedar
NAILING	Single Nailed
NAILS	Aluminum Spiral Nails
WIDTH	92.5" Actual
RAILS	STANDARD: All Rails 1" x 4" x 8" Red Cedar (Nominal) OPTIONAL: Bottom Rails 1" x 6" x 8" Red Cedar (Nominal) (Add \$ per side)
TABS	NONE
OPTIONAL	Rail Edging (← See styles and pricing)
GATES	Matching gates available. Please CALL for more information

RAIL EDGING STYLES (PRICED PER CORNER)					
\$ ←  → \$					
BASIC	A	B	C	D	E
\$	Add \$ Ea.	Add \$ Ea.	Add \$ Ea.	Add \$ Ea.	Add \$ Ea.

### 703 STYLE 3-RAIL STAGGERED WESTERN RED CEDAR CLASSIC VICTORIAN PICKET

Item #	Board Rail Style	Description	Each
703-3	SEE ABOVE	3'H   Spaced   Western Red Cedar Pickets   Pointed Victorian Tops   Style 703   3-Rail Staggered	
703-4	SEE ABOVE	4'H   Spaced   Western Red Cedar Pickets   Pointed Victorian Tops   Style 703   3-Rail Staggered	
703-5	SEE ABOVE	5'H   Spaced   Western Red Cedar Pickets   Pointed Victorian Tops   Style 703   3-Rail Staggered	
703-6	SEE ABOVE	6'H   Spaced   Western Red Cedar Pickets   Pointed Victorian Tops   Style 703   3-Rail Staggered	

**MATCHING GATES AVAILABLE**

**PLEASE NOTE: ONCE DELIVERED, EASTERN WOOD FENCE IS NON-REFUNDABLE.**

Wood fence is a natural product and natural weathering including splitting, warping, twisting, checking, raised grain, swelling, shrinkage, surface mold and/or mildew, fungi, or any other physical property of the wood including but not limited to knots can occur.

# CLAS. VIC. PICK. 705 TOP-RAIL STAGGERED



## 705 STYLE CLASSIC VICTORIAN PICKET

3', 4', and 5' Height Straight Top-Rail Staggered Red Cedar Spaced Picket Fence

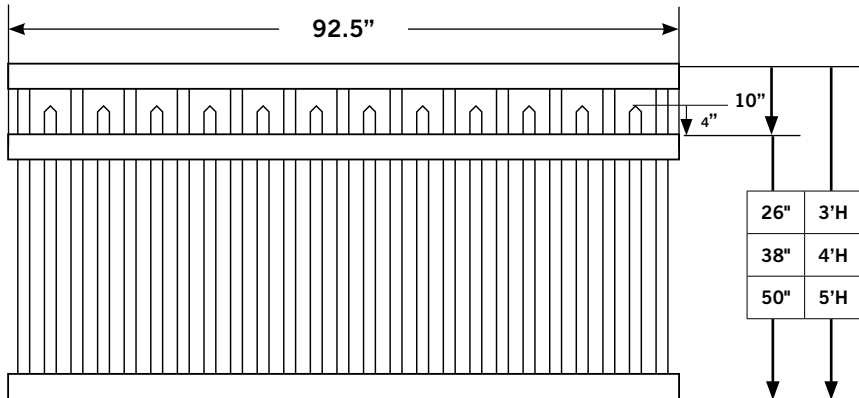

PICKETS	Nominal 2" x 2" / 25 Per Section
SPACING	STANDARD: Nominal Between 2" and 2-1/4" OPTIONAL: Other spacing available. Example: 1-3/4", 1-7/8", etc.
SPECIES	Red Cedar
NAILING	Single Nailed
NAILS	Aluminum Spiral Nails
WIDTH	92.5" Actual
RAILS	STANDARD: All Rails 1" x 4" x 8" Red Cedar (Nominal) OPTIONAL: Bottom Rails 1" x 6" x 8" Red Cedar (Nominal) (Add \$ per side)
TABS	NONE
OPTIONAL	Rail Edging (← See styles and pricing)
GATES	Matching gates available. Please CALL for more information

RAIL EDGING STYLES (PRICED PER CORNER)					
\$ ←  → \$					
BASIC	A	B	C	D	E
\$	Add \$ Ea.	Add \$ Ea.	Add \$ Ea.	Add \$ Ea.	Add \$ Ea.

## 705 STYLE TOP-RAIL STAGGERED WESTERN RED CEDAR CLASSIC VICTORIAN PICKET

Item #	Board Rail Style	Description	Each
705-3	SEE ABOVE	3'H   Spaced   Western Red Cedar Pickets   Pointed Victorian Tops   Style 705   Top-Rail Staggered	
705-4	SEE ABOVE	4'H   Spaced   Western Red Cedar Pickets   Pointed Victorian Tops   Style 705   Top-Rail Staggered	
705-5	SEE ABOVE	5'H   Spaced   Western Red Cedar Pickets   Pointed Victorian Tops   Style 705   Top-Rail Staggered	
705-6	SEE ABOVE	6'H   Spaced   Western Red Cedar Pickets   Pointed Victorian Tops   Style 705   Top-Rail Staggered	

MATCHING GATES AVAILABLE

**PLEASE NOTE: ONCE DELIVERED, EASTERN WOOD FENCE IS NON-REFUNDABLE.**

Wood fence is a natural product and natural weathering including splitting, warping, twisting, checking, raised grain, swelling, shrinkage, surface mold and/or mildew, fungi, or any other physical property of the wood including but not limited to knots can occur.

# CLAS. VIC. PICK. 706 STEPPED



## 706 STYLE CLASSIC VICTORIAN PICKET

3', 4', and 5' Height Stepped Red Cedar Spaced Picket Fence

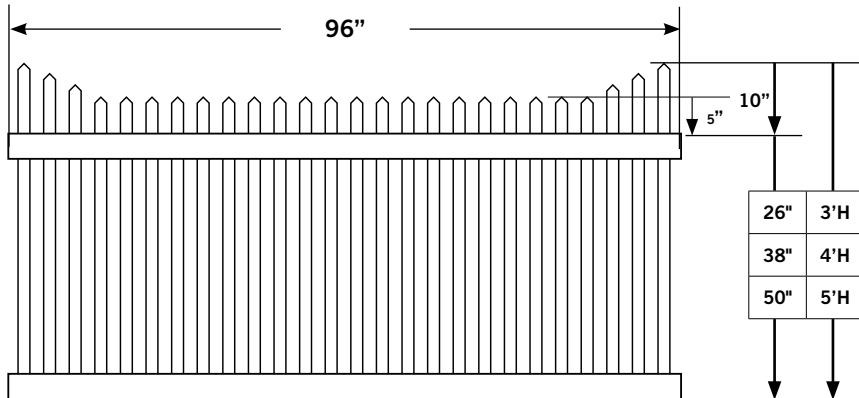

PICKETS	Nominal 2" x 2" / 26 Per Section
SPACING	STANDARD: Nominal Between 2" and 2-1/4"
	OPTIONAL: Other spacing available. Example: 1-3/4", 1-7/8", etc.
SPECIES	Red Cedar
NAILING	Single Nailed
NAILS	Aluminum Spiral Nails
WIDTH	96" Actual
RAILS	STANDARD: All Rails 1" x 4" x 8" Red Cedar (Nominal)
	OPTIONAL: Bottom Rails 1" x 6" x 8" Red Cedar (Nominal) (Add \$ per side)
TABS	NONE
OPTIONAL	Rail Edging (← See styles and pricing)
GATES	Matching gates available. Please CALL for more information

RAIL EDGING STYLES (PRICED PER CORNER)					
\$ ←  → \$					
BASIC	A	B	C	D	E
\$	Add \$ Ea.	Add \$ Ea.	Add \$ Ea.	Add \$ Ea.	Add \$ Ea.

## 706 STYLE STEPPED WESTERN RED CEDAR CLASSIC VICTORIAN PICKET

Item #	Board Rail Style	Description	Each
706-3	SEE ABOVE	3'H   Spaced   Western Red Cedar Pickets   Pointed Victorian Tops   Style 706   Stepped	
706-4	SEE ABOVE	4'H   Spaced   Western Red Cedar Pickets   Pointed Victorian Tops   Style 706   Stepped	
706-5	SEE ABOVE	5'H   Spaced   Western Red Cedar Pickets   Pointed Victorian Tops   Style 706   Stepped	
706-6	SEE ABOVE	6'H   Spaced   Western Red Cedar Pickets   Pointed Victorian Tops   Style 706   Stepped	

**MATCHING GATES AVAILABLE**

**PLEASE NOTE: ONCE DELIVERED, EASTERN WOOD FENCE IS NON-REFUNDABLE.**

Wood fence is a natural product and natural weathering including splitting, warping, twisting, checking, raised grain, swelling, shrinkage, surface mold and/or mildew, fungi, or any other physical property of the wood including but not limited to knots can occur.

# CLAS. VIC. PICK. 707 SCALLOPED



## 707 STYLE CLASSIC VICTORIAN PICKET

3', 4', and 5' Height Scalloped Red Cedar Spaced Picket Fence

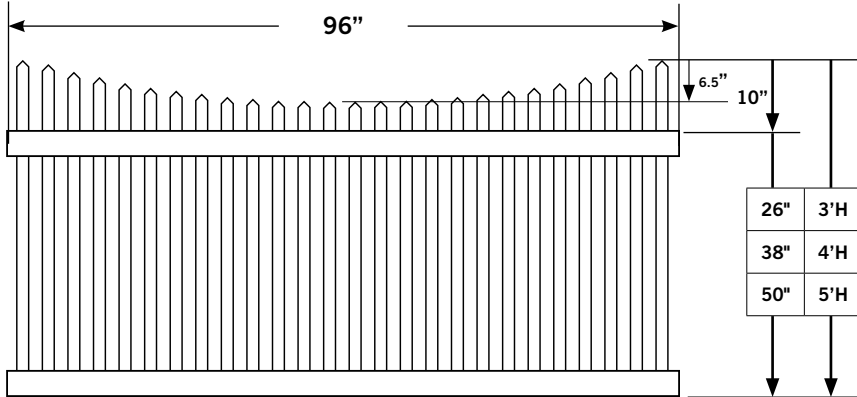

PICKETS	Nominal 2" x 2" / 25 Per Section
SPACING	STANDARD: Nominal Between 2" and 2-1/4"
	OPTIONAL: Other spacing available. Example: 1-3/4", 1-7/8", etc.
SPECIES	Red Cedar
NAILING	Single Nailed
NAILS	Aluminum Spiral Nails
WIDTH	96" Actual
RAILS	STANDARD: All Rails 1" x 4" x 8" Red Cedar (Nominal)
	OPTIONAL: Bottom Rails 1" x 6" x 8" Red Cedar (Nominal) (Add \$ per side)
TABS	NONE
OPTIONAL	Rail Edging (← See styles and pricing)
GATES	Matching gates available. Please CALL for more information

RAIL EDGING STYLES (PRICED PER CORNER)					
\$ ← → \$					
<b>BASIC</b>	<b>A</b>	<b>B</b>	<b>C</b>	<b>D</b>	<b>E</b>
\$	Add \$ Ea.	Add \$ Ea.	Add \$ Ea.	Add \$ Ea.	Add \$ Ea.

## 707 STYLE SCALLOPED WESTERN RED CEDAR CLASSIC VICTORIAN PICKET

Item #	Board Rail Style	Description	Each
707-3	SEE ABOVE	3'H   Spaced   Western Red Cedar Pickets   Pointed Victorian Tops   Style 707   Scalloped	
707-4	SEE ABOVE	4'H   Spaced   Western Red Cedar Pickets   Pointed Victorian Tops   Style 707   Scalloped	
707-5	SEE ABOVE	5'H   Spaced   Western Red Cedar Pickets   Pointed Victorian Tops   Style 707   Scalloped	
707-6	SEE ABOVE	6'H   Spaced   Western Red Cedar Pickets   Pointed Victorian Tops   Style 707   Scalloped	

MATCHING GATES AVAILABLE

**PLEASE NOTE: ONCE DELIVERED, EASTERN WOOD FENCE IS NON-REFUNDABLE.**

Wood fence is a natural product and natural weathering including splitting, warping, twisting, checking, raised grain, swelling, shrinkage, surface mold and/or mildew, fungi, or any other physical property of the wood including but not limited to knots can occur.

# HORIZONTAL

## Semi-Privacy Fence



### Cedar Horizontal 6' Wide

Item code: HOR14-66  
Made with 1" x 4" x 6' cedar boards  
Approximately 1/2" space between boards  
Sandwiched between 1x2 cedar boards to hold together  
Comes assembled  
Cap board not included



### Cedar Horizontal 8' Wide

Item code: HOR16-68  
Made with 1" x 6" x 8' cedar boards  
Approximately 1/2" space between boards  
Sandwiched between 1x2 cedar boards to hold together  
Comes assembled  
Cap board not included



*The Next Generation of Wood Fence!*

[www.easternwoodfence.com](http://www.easternwoodfence.com)



HORIZONTAL WOOD FENCE 0522 | ©2022 EASTERN WHOLESALE FENCE LLC | ALL RIGHTS RESERVED



## HORIZONTAL WOOD FENCE



**HOR14-66**  
CEDAR HORIZONTAL 6' WIDE



**HOR16-68**  
CEDAR HORIZONTAL 8' WIDE

# HORIZONTAL HORIZONTAL 1 x 4 SECTION



## HOR14-56/66

### 5', 6' Height Cedar Horizontal Fence

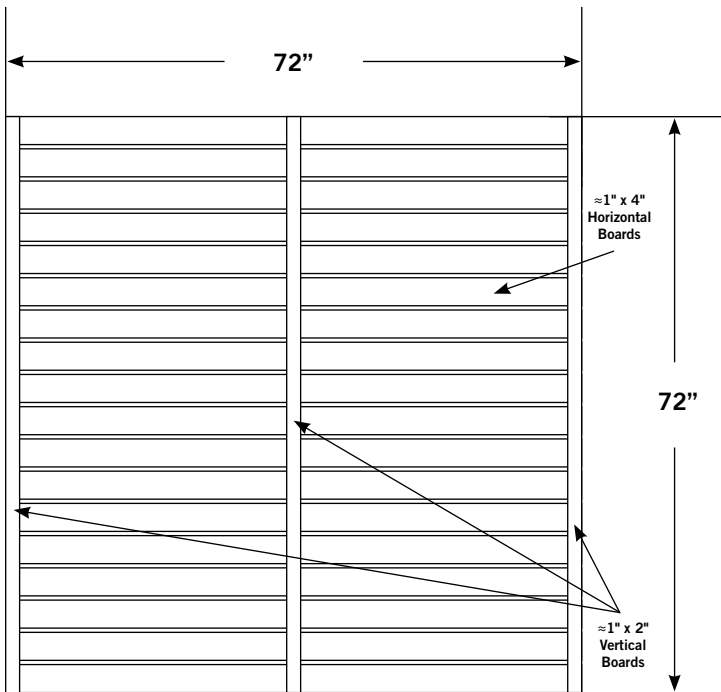

BOARDS	Nominal 1" x 4" / 18 Per Section (Side and Center Strips Included)
SPACING	½" Between Horizontal Boards
SPECIES	STANDARD: White Cedar OPTIONAL: Red Cedar (Call for Pricing)
NAILING	Aluminum Spiral Nails
WIDTH	96" Exact
RAILS	Nominal 1" x 4" Horizontal Boards

Eastern Horizontal 14 Fence is made with 1" x 4" nominal White Cedar boards with 1" x 2" strips nailed at each end and one in center for stability, this panel is built the same way on both sides to give the neighbor friendly fence appeal.

## HORIZONTAL 1" x 6"

Item #	Description	Each
HOR14-56	Horizontal Face   Cedar   Style HOR14 in 5'H	
HOR14-66	Horizontal Face   Cedar   Style HOR14 in 6'H	

**PLEASE NOTE: ONCE DELIVERED, EASTERN WOOD FENCE IS NON-REFUNDABLE.** Wood fence is a natural product and natural weathering including splitting, warping, twisting, checking, raised grain, swelling, shrinkage, surface mold and/or mildew, fungi, or any other physical property of the wood including but not limited to knots can occur.

# HORIZONTAL HORIZONTAL 1 x 6 SECTION



## HOR16-48/58/68/88

4', 5', 6', 8' Height  
Cedar Horizontal Fence

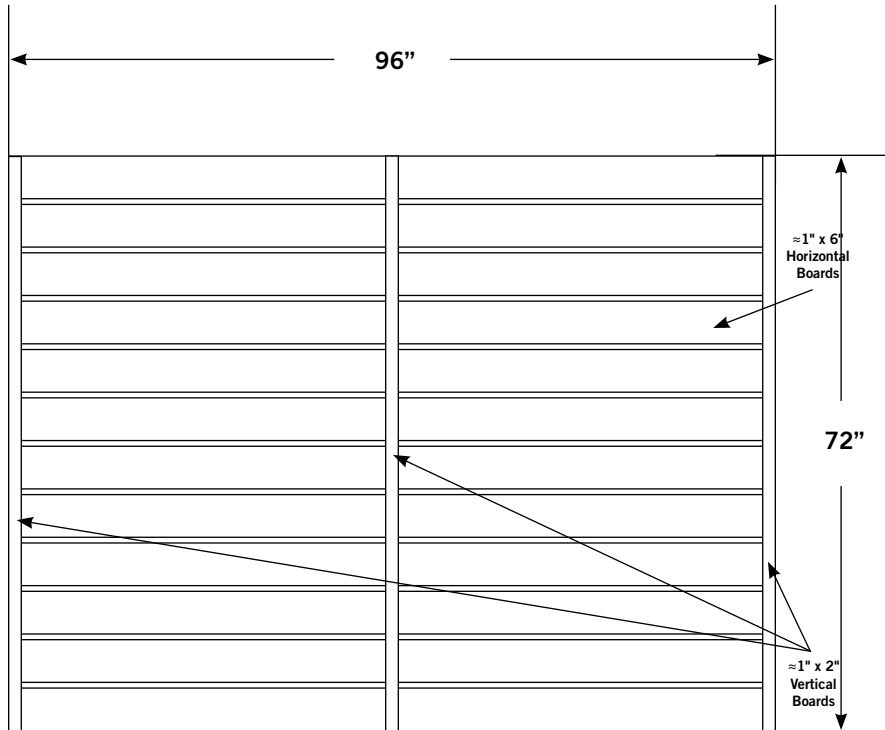

BOARDS	Nominal 1" x 6" / 12 Per Section (Side and Center Strips Included)
SPACING	1/2" Between Horizontal Boards
SPECIES	STANDARD: White Cedar OPTIONAL: Red Cedar (Call for Pricing)
NAILING	Aluminum Spiral Nails
WIDTH	96" Exact
RAILS	STANDARD: Nominal 1" x 6" Horizontal Boards

Eastern Horizontal 16 Fence is made with 1 x 6 nominal White Cedar boards with 1 x 2 strips nailed at each end and one in center for stability, this panel is built the same way on both sides to give the neighbor friendly fence appeal.

### HORIZONTAL 1" x 6"

Item #	Description	Each
HOR16-48	Horizontal Face   Cedar   Style HOR16 in 4'H	
HOR16-58	Horizontal Face   Cedar   Style HOR16 in 5'H	
HOR16-68	Horizontal Face   Cedar   Style HOR16 in 6'H	
HOR16-88	Horizontal Face   Cedar   Style HOR16 in 8'H	

**PLEASE NOTE: ONCE DELIVERED, EASTERN WOOD FENCE IS NON-REFUNDABLE.** Wood fence is a natural product and natural weathering including splitting, warping, twisting, checking, raised grain, swelling, shrinkage, surface mold and/or mildew, fungi, or any other physical property of the wood including but not limited to knots can occur.

**NEW ITEM ALERT**

# **6" Pressure Treated Dog-Ear Wood Fence In Stock!**



*Call for Pricing!*



Eastern Wood Fence  
[easternwoodfence.com](http://easternwoodfence.com)



# PRESSURE TREATED 1 x 6 DOG-EAR SECTION

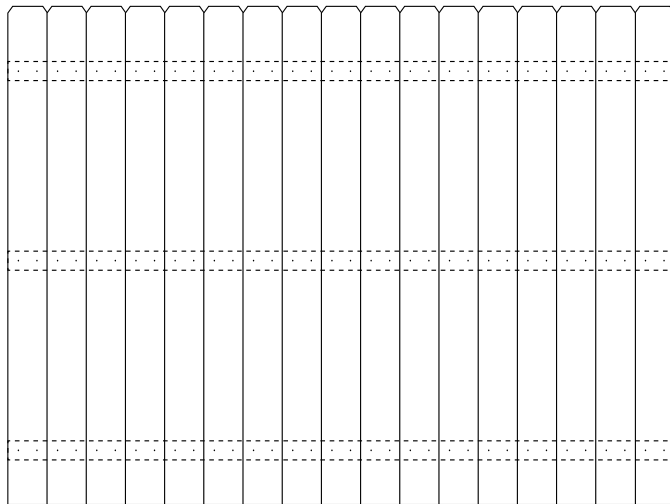
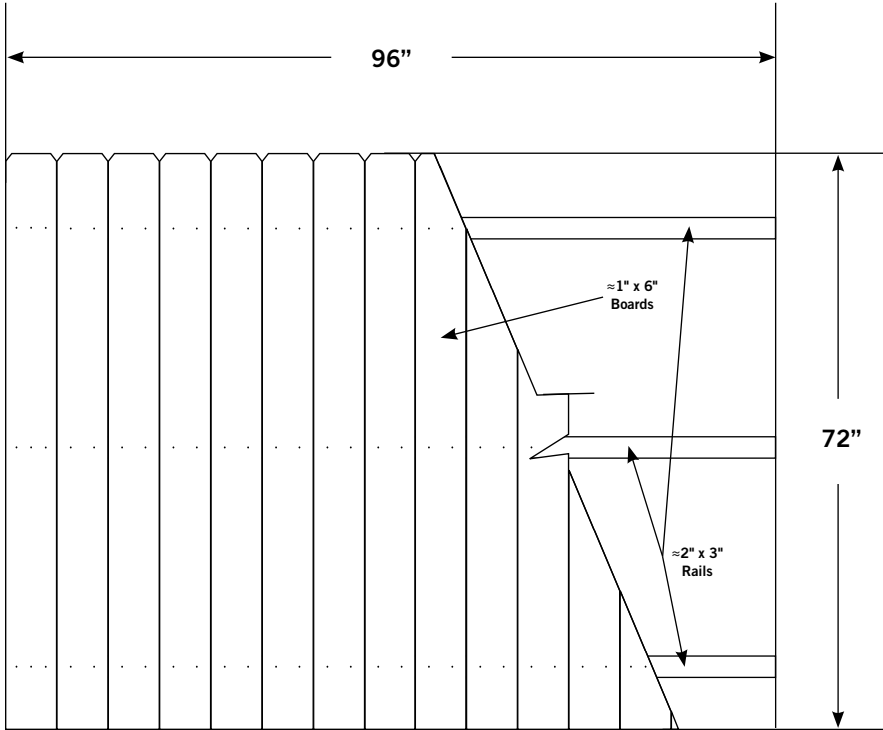

## PTDE346

**6' High by 8' Wide Pressure-Treated Pine Privacy Section with 6" (Nominal) Dog-Ear Boards and Pine Backrails.**

BOARDS Nominal 1" x 6" / 17 Per Section  
Pressure Treated Pine

SPECIES STANDARD: Pressure Treated Pine

NAILS Hot Dipped Galv

WIDTH 96"

RAILS Nominal 2" x 3" / 3 Per Section  
Pressure Treated Pine

### NEW ITEM ALERT

**6" Pressure Treated  
Dog-Ear Wood Fence  
In Stock!**



Eastern Wood Fence  
easternwoodfence.com



Eastern Pressure Treated Dog-Ear Privacy Fence is made with 1" x 6" nominal pressure-treated pine boards.

## PRESSURE TREATED 1" x 6" DOG-EAR SECTION

Item #	Description	Each
PTDE346	Solid   Pressure-Treated Pine   Dog-Ear 6" Boards   6'H	

**PLEASE NOTE: ONCE DELIVERED, EASTERN WOOD FENCE IS NON-REFUNDABLE.** Wood fence is a natural product and natural weathering including splitting, warping, twisting, checking, raised grain, swelling, shrinkage, surface mold and/or mildew, fungi, or any other physical property of the wood including but not limited to knots can occur.



## WHITE CEDAR - BOARD ON BOARD



**210**



**310**



**210 BOTTOM**  
WITH 215-1 TOP

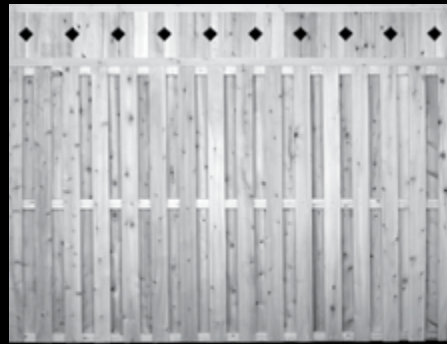

**210 BOTTOM**  
WITH 400-1 TOP



**210 BOTTOM**  
WITH 800-1 TOP

# BOARD ON BOARD 310 STYLE

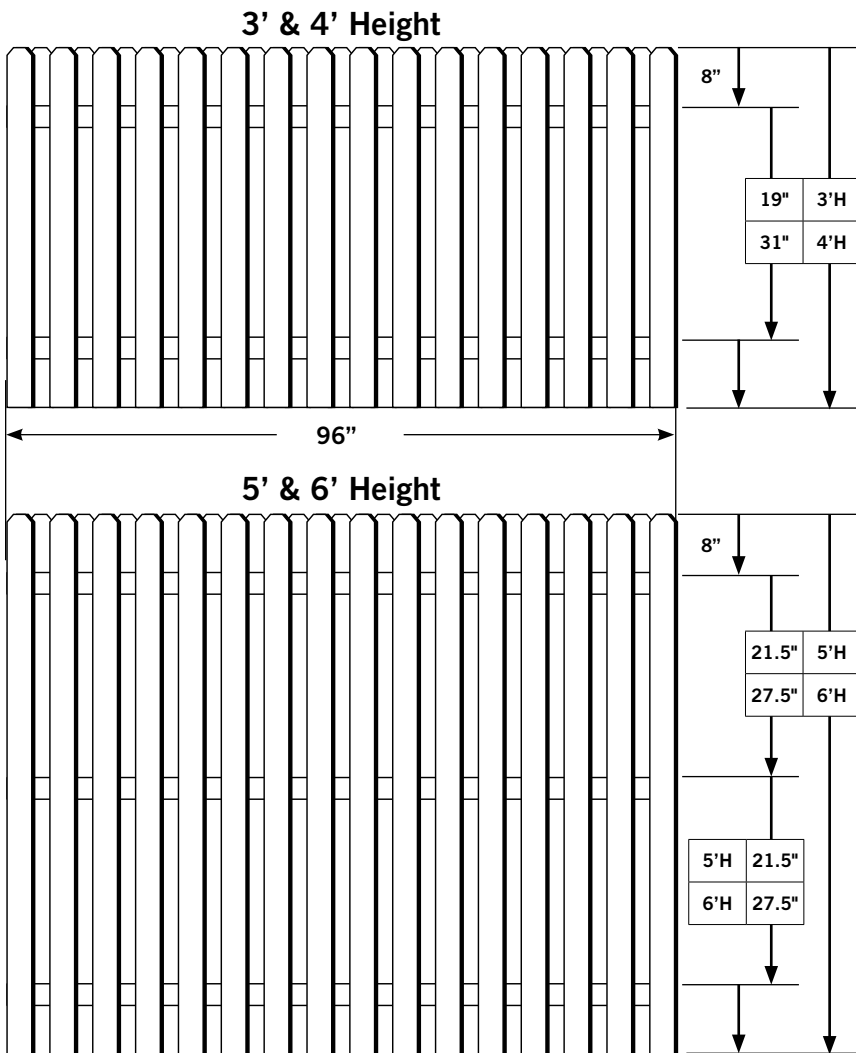

## 310 STYLE BOARD ON BOARD WITH #5 Style Boards

3', 4', 5', 6' Height Cedar Board on Board Panel with #5 Style Boards

**BOARDS** STANDARD: Nominal 1" x 4" / 31 Per section. 15 on one side, 16 on the other.  
 OPTIONAL: Nominal Red Cedar 1" x 6" x 8" (Call for quote)

**SPACING** Nominal 2-1/2" - 2-3/4" between boards. Boards overlap each other front and back by approx. 1/2". (See top view)



**SPECIES** STANDARD: White Cedar  
 OPTIONAL: Red Cedar (Call for Pricing)

**NAILING** Double Nailed Top and Bottom Rails, Single Nailed Middle Rail

**NAILS** Aluminum Spiral Nails

**WIDTH** 96" Wide Actual

**RAILS** STANDARD: 2" x 3" Nominal Cedar  
 OPTIONAL: 2" x 3" Nominal Spruce  
 OPTIONAL: Dowelled backrails.  
 (Measurements may deviate from standard. Call for pricing and info)

### PICKET TOP STYLES

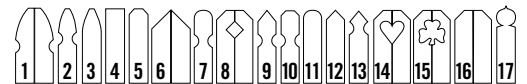

## SPRUCE BACKRAILS

Item #	Backrails	Description						Each
3562-310	SPRUCE 3'H	Board on Board	Spruce Backrails	Cedar Boards	#5 Style Picket Tops	Style 310		
4562-310	SPRUCE 4'H	Board on Board	Spruce Backrails	Cedar Boards	#5 Style Picket Tops	Style 310		
5562-310	SPRUCE 5'H	Board on Board	Spruce Backrails	Cedar Boards	#5 Style Picket Tops	Style 310		
6562-310	SPRUCE 6'H	Board on Board	Spruce Backrails	Cedar Boards	#5 Style Picket Tops	Style 310		
8562-310	SPRUCE 8'H	Board on Board	Spruce Backrails	Cedar Boards	#5 Style Picket Tops	Style 310		

## CEDAR BACKRAILS

Item #	Backrails	Description						Each
3572-310	CEDAR 3'H	Board on Board	Cedar Backrails	Cedar Boards	#5 Style Picket Tops	Style 310		
4572-310	CEDAR 4'H	Board on Board	Cedar Backrails	Cedar Boards	#5 Style Picket Tops	Style 310		
5572-310	CEDAR 5'H	Board on Board	Cedar Backrails	Cedar Boards	#5 Style Picket Tops	Style 310		
6572-310*	CEDAR 6'H	Board on Board	Cedar Backrails	Cedar Boards	#5 Style Picket Tops	Style 310	STOCKING ITEM	
8572-310	CEDAR 8'H	Board on Board	Cedar Backrails	Cedar Boards	#5 Style Picket Tops	Style 310		

**PLEASE NOTE: ONCE DELIVERED, EASTERN WOOD FENCE IS NON-REFUNDABLE.**

Wood fence is a natural product and natural weathering including splitting, warping, twisting, checking, raised grain, swelling, shrinkage, surface mold and/or mildew, fungi, or any other physical property of the wood including but not limited to knots can occur.

# BOARD ON BOARD 210 STYLE "SHADOW BOX"



3' & 4' Height

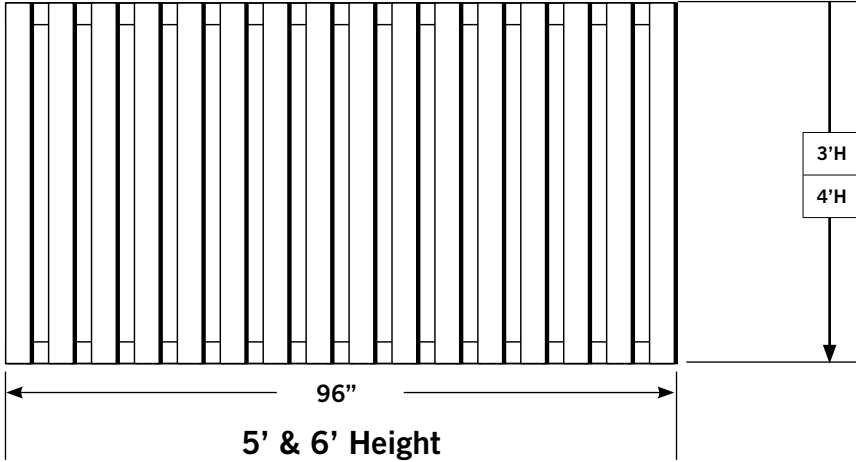

5' & 6' Height

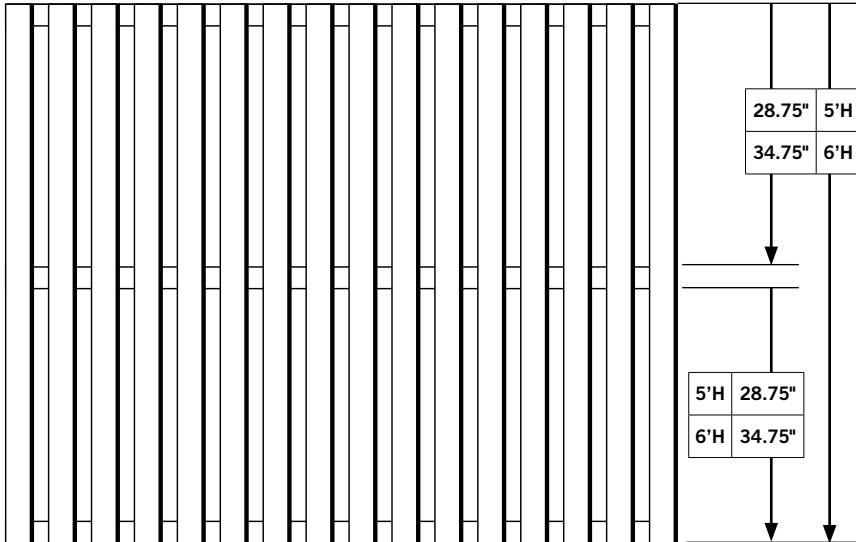

## 210 STYLE BOARD ON BOARD PANEL "SHADOWBOX"

3', 4', 5', 6' Height Cedar Board on Board Panel with #4 Style Boards

**BOARDS** STANDARD: Nominal 1" x 4" / 31 Per Section. 15 on one side, 16 on the other.  
OPTIONAL: Nominal Red Cedar 1" x 6" x 8" (Call for quote)

**SPACING** Nominal 2-1/2" - 2-3/4" between boards. Boards overlap each other front and back by approx. 1/2". (See top view)

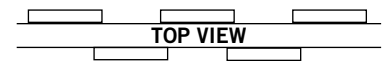

**SPECIES** STANDARD: White Cedar  
OPTIONAL: Red Cedar (Call for Pricing)

**NAILING** Double Nailed Top and Bottom Rails, Single Nailed Middle Rail

**NAILS** Aluminum Spiral Nails

**WIDTH** 96" Wide Actual

**RAILS** STANDARD: 2" x 3" Nominal Cedar  
OPTIONAL: 2" x 3" Nominal Spruce  
OPTIONAL: Dowelled backrails.  
(Measurements may deviate from standard. Call for pricing and info)

### PICKET TOP STYLES

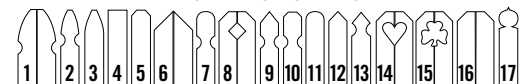

## SPRUCE BACKRAILS

Item #	Backrails	Description						Each
3562-210	SPRUCE 3'H	Board on Board	Spruce Backrails	Cedar Boards	#4 Style Picket Tops	Style 210		
4562-210	SPRUCE 4'H	Board on Board	Spruce Backrails	Cedar Boards	#4 Style Picket Tops	Style 210		
5562-210	SPRUCE 5'H	Board on Board	Spruce Backrails	Cedar Boards	#4 Style Picket Tops	Style 210		
6562-210	SPRUCE 6'H	Board on Board	Spruce Backrails	Cedar Boards	#4 Style Picket Tops	Style 210		
8562-210	SPRUCE 8'H	Board on Board	Spruce Backrails	Cedar Boards	#4 Style Picket Tops	Style 210		

## CEDAR BACKRAILS

Item #	Backrails	Description						Each
3572-210	CEDAR 3'H	Board on Board	Cedar Backrails	Cedar Boards	#4 Style Picket Tops	Style 210		
4572-210	CEDAR 4'H	Board on Board	Cedar Backrails	Cedar Boards	#4 Style Picket Tops	Style 210		
5572-210	CEDAR 5'H	Board on Board	Cedar Backrails	Cedar Boards	#4 Style Picket Tops	Style 210		
6572-210	CEDAR 6'H	Board on Board	Cedar Backrails	Cedar Boards	#4 Style Picket Tops	Style 210		
8572-210	CEDAR 8'H	Board on Board	Cedar Backrails	Cedar Boards	#4 Style Picket Tops	Style 210		

**PLEASE NOTE: ONCE DELIVERED, EASTERN WOOD FENCE IS NON-REFUNDABLE.**

Wood fence is a natural product and natural weathering including splitting, warping, twisting, checking, raised grain, swelling, shrinkage, surface mold and/or mildew, fungi, or any other physical property of the wood including but not limited to knots can occur.

# B-on-B CREATE YOUR OWN 210 STYLE B-on-B w/TOPPER

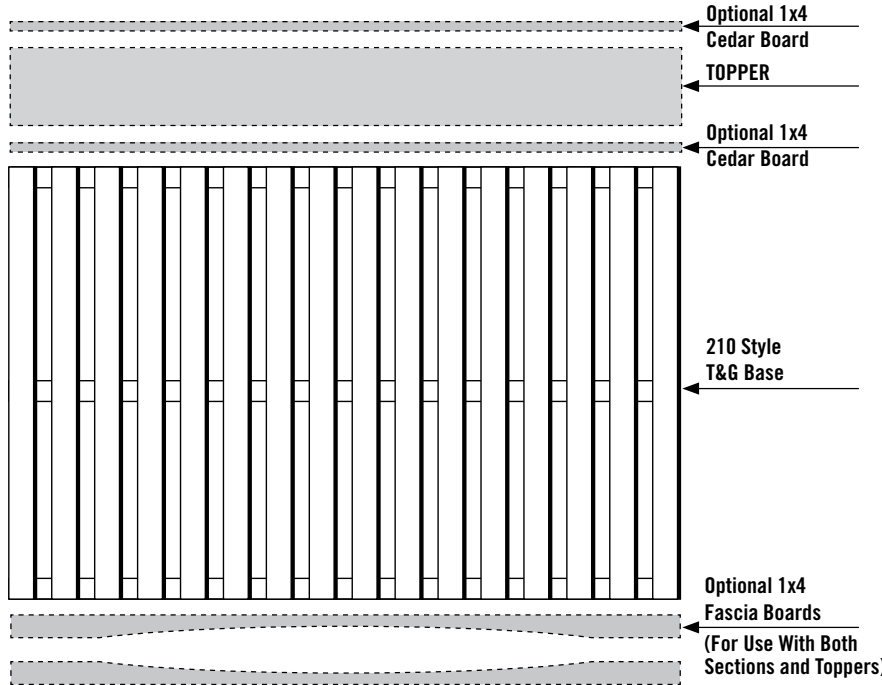

## CREATE YOUR OWN 210 STYLE BOARD ON BOARD SECTION WITH TOPPER

- NOTES
1. Order your 210 style base (comes fully assembled)
  2. Order the topper you're looking for (comes fully assembled)
  3. Order an optional 1x4 cedar board (CD148) BETWEEN the base and the topper (add onsite)
  4. Order an optional 1x4 cedar board (CD148) for ON TOP of the topper (add onsite)
  5. Order optional fascia boards (FASCIA1X4). (IMPORTANT! Fascia boards can be ordered individually or added during the manufacturing process (additional charges may apply). When requesting fascia boards for any section or topper, you must specify the quantity and location (TOP/BOTTOM, FRONT/BACK) at the time of your order.)

TO CREATE THIS SECTION, THE BASE, TOPPER, FASCIA, and OPTIONAL CEDAR BOARDS ARE ALL SOLD SEPARATELY

### 210 STYLE BASE SPRUCE BACKRAILS

Item #	Backrails	Description	Each
3562-210	SPRUCE	3'H Board on Board Spruce Backrails Cedar Boards #4 Style Picket Tops Style 210	
4562-210	SPRUCE	4'H Board on Board Spruce Backrails Cedar Boards #4 Style Picket Tops Style 210	
5562-210	SPRUCE	5'H Board on Board Spruce Backrails Cedar Boards #4 Style Picket Tops Style 210	
6562-210	SPRUCE	6'H Board on Board Spruce Backrails Cedar Boards #4 Style Picket Tops Style 210	
8562-210	SPRUCE	8'H Board on Board Spruce Backrails Cedar Boards #4 Style Picket Tops Style 210	

### CEDAR BACKRAILS

Item #	Backrails	Description	Each
3572-210	CEDAR	3'H Board on Board Cedar Backrails Cedar Boards #4 Style Picket Tops Style 210	
4572-210	CEDAR	4'H Board on Board Cedar Backrails Cedar Boards #4 Style Picket Tops Style 210	
5572-210	CEDAR	5'H Board on Board Cedar Backrails Cedar Boards #4 Style Picket Tops Style 210	
6572-210	CEDAR	6'H Board on Board Cedar Backrails Cedar Boards #4 Style Picket Tops Style 210	
8572-210	CEDAR	8'H Board on Board Cedar Backrails Cedar Boards #4 Style Picket Tops Style 210	

### TOPPER

Item #	Description	Each
700-1	12" Height Classic Victorian Picket Topper	
701-1	12" Height Framed Classic Victorian Picket Topper	
707-1	12" Height Scalloped Classic Victorian Picket Topper	
400-1	12" Height Diamond Tongue and Groove Topper	
400H-1	12" Height Heart Tongue and Groove Topper	
400S-1	12" Height Shamrock Tongue and Groove Topper	
215-1*	12.5" Height Diagonal Lattice Topper	STOCKING ITEM
SQL18*	13.25" Height Square Lattice Topper	STOCKING ITEM
0T-1	13.5" Height Rings Topper	
800-1	12" Height Criss-Cross Style Topper	

### ADDITIONAL OPTIONS

Item #	Description	Each
CD148	1 x 4 x 8 Cedar Board #1	
FASCIA1X4	1 x 4 x 8 Cedar FASCIA Board #1 (IMPORTANT! Fascia boards can be ordered individually or added during the manufacturing process (additional charges may apply). When requesting fascia boards for any section or topper, you must specify the quantity and location (TOP/BOTTOM, FRONT/BACK) at the time of your order.)	

**PLEASE NOTE: ONCE DELIVERED, EASTERN WOOD FENCE IS NON-REFUNDABLE.** Wood fence is a natural product and natural weathering including splitting, warping, twisting, checking, raised grain, swelling, shrinkage, surface mold and/or mildew, fungi, or any other physical property of the wood including but not limited to knots can occur.

# B-on-B 210 BOTTOM w/ 215-1 TOPPER

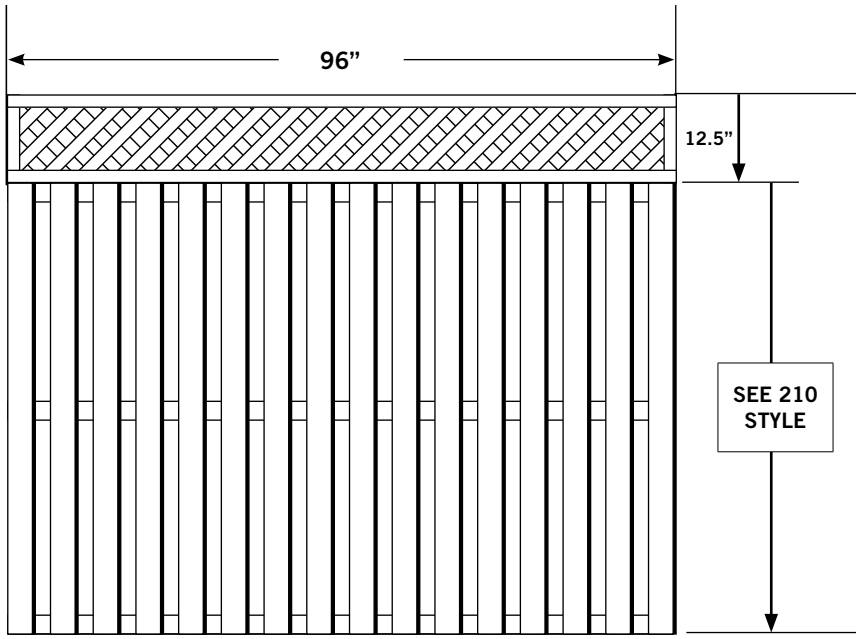

**215-1 Lattice Topper**

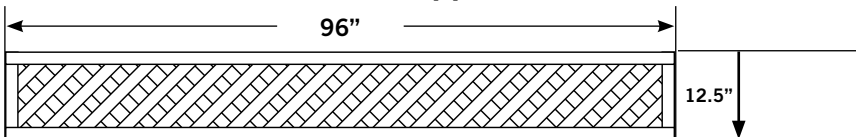

Eastern 215-1 wood fence toppers are made sturdy and strong out of thick 2"x 2" (nominal) cross-members nailed together by 1" x 3" (nominal) boards. (See lattice top view.)

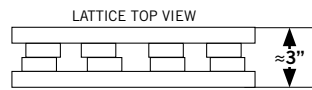

## 210 STYLE BOARD ON BOARD WITH 215-1 TOPPER

3', 4', 5', 6' Height Cedar Board on Board Panel with #5 Style Boards

**BOARDS** STANDARD: Nominal 1" x 4" / 31 Per section. 15 on one side, 16 on the other.  
 OPTIONAL: Nominal Red Cedar 1" x 6" x 8" (Call for quote)

**SPACING** Nominal 2-1/2" - 2-3/4" between boards. Boards overlap each other front and back by approx. 1/2". (See top view)



**SPECIES** STANDARD: White Cedar  
 OPTIONAL: Red Cedar (Call for Pricing)

**NAILING** Double Nailed Top and Bottom Rails, Single Nailed Middle Rail

**NAILS** Aluminum Spiral Nails

**WIDTH** 96" Wide Actual

**RAILS** STANDARD: 2" x 3" Nominal Cedar  
 OPTIONAL: 2" x 3" Nominal Spruce  
 OPTIONAL: Dowelled backrails.  
 (Measurements may deviate from standard. Call for pricing and info)

**TO CREATE THIS SECTION, THE BASE, TOPPER, FASCIA, and OPTIONAL CEDAR BOARDS ARE ALL SOLD SEPARATELY**

### 210 STYLE BASE

#### SPRUCE BACKRAILS

Item #	Backrails	Description	Each
3562-210	SPRUCE	3'H Board on Board Spruce Backrails Cedar Boards #4 Style Picket Tops Style 210	
4562-210	SPRUCE	4'H Board on Board Spruce Backrails Cedar Boards #4 Style Picket Tops Style 210	
5562-210	SPRUCE	5'H Board on Board Spruce Backrails Cedar Boards #4 Style Picket Tops Style 210	
6562-210	SPRUCE	6'H Board on Board Spruce Backrails Cedar Boards #4 Style Picket Tops Style 210	
8562-210	SPRUCE	8'H Board on Board Spruce Backrails Cedar Boards #4 Style Picket Tops Style 210	

#### CEDAR BACKRAILS

Item #	Backrails	Description	Each
3572-210	CEDAR	3'H Board on Board Cedar Backrails Cedar Boards #4 Style Picket Tops Style 210	
4572-210	CEDAR	4'H Board on Board Cedar Backrails Cedar Boards #4 Style Picket Tops Style 210	
5572-210	CEDAR	5'H Board on Board Cedar Backrails Cedar Boards #4 Style Picket Tops Style 210	
6572-210	CEDAR	6'H Board on Board Cedar Backrails Cedar Boards #4 Style Picket Tops Style 210	
8572-210	CEDAR	8'H Board on Board Cedar Backrails Cedar Boards #4 Style Picket Tops Style 210	

### TOPPER

Item #	Description	Each
215-1*	12.5" Height Diagonal Lattice Topper <span style="border: 1px solid black; padding: 2px;">STOCKING ITEM</span>	

### ADDITIONAL OPTIONS

Item #	Description	Each
CD148	1 x 4 x 8 Cedar Board #1	
FASCIA1X4	1 x 4 x 8 Cedar FASCIA Board #1 (IMPORTANT! Fascia boards can be ordered individually or added during the manufacturing process (additional charges may apply). When requesting fascia boards for any section or topper, you must specify the quantity and location (TOP/BOTTOM, FRONT/BACK) at the time of your order.)	

**PLEASE NOTE: ONCE DELIVERED, EASTERN WOOD FENCE IS NON-REFUNDABLE.** Wood fence is a natural product and natural weathering including splitting, warping, twisting, checking, raised grain, swelling, shrinkage, surface mold and/or mildew, fungi, or any other physical property of the wood including but not limited to knots can occur.

# B-on-B 210 BOTTOM w/ 400-1 TOPPER

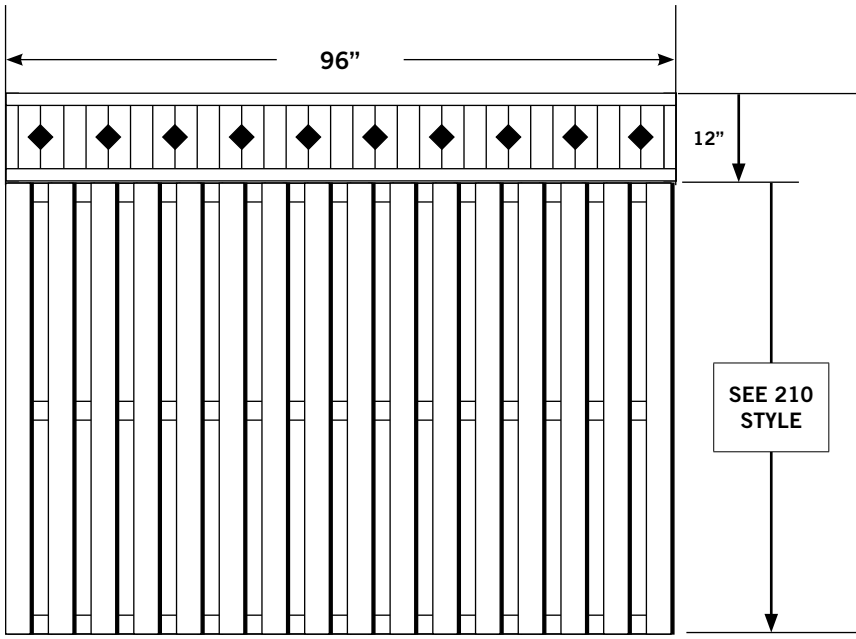

400-1 Lattice Topper

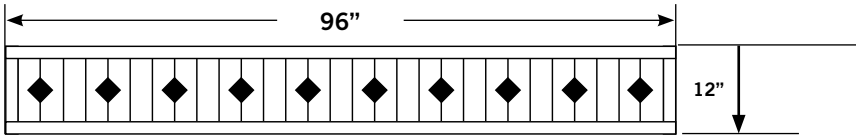

Eastern 400-1 wood fence toppers are made sturdy and strong out of 1" x 4" (nominal) cedar boards. (See lattice top view.)

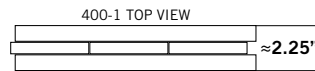

## 210 STYLE BOARD ON BOARD WITH 400-1 TOPPER

3', 4', 5', 6' Height Cedar Board on Board Panel with #4 Style Boards

**BOARDS** STANDARD: Nominal 1" x 4" / 31 Per section. 15 on one side, 16 on the other.  
 OPTIONAL: Nominal Red Cedar 1" x 6" x 8" (Call for quote)

**SPACING** Nominal 2-1/2" - 2-3/4" between boards. Boards overlap each other front and back by approx. 1/2". (See top view)



**SPECIES** STANDARD: White Cedar  
 OPTIONAL: Red Cedar (Call for Pricing)

**NAILING** Double Nailed Top and Bottom Rails, Single Nailed Middle Rail

**NAILS** Aluminum Spiral Nails

**WIDTH** 96" Wide Actual

**RAILS** STANDARD: 2" x 3" Nominal Cedar  
 OPTIONAL: 2" x 3" Nominal Spruce  
 OPTIONAL: Dowelled backrails.  
 (Measurements may deviate from standard. Call for pricing and info)

**TO CREATE THIS SECTION, THE BASE, TOPPER, FASCIA, and OPTIONAL CEDAR BOARDS ARE ALL SOLD SEPARATELY**

### 210 STYLE BASE SPRUCE BACKRAILS

Item #	Backrails	Description	Each
3562-210	SPRUCE	3'H Board on Board Spruce Backrails Cedar Boards #4 Style Picket Tops Style 210	
4562-210	SPRUCE	4'H Board on Board Spruce Backrails Cedar Boards #4 Style Picket Tops Style 210	
5562-210	SPRUCE	5'H Board on Board Spruce Backrails Cedar Boards #4 Style Picket Tops Style 210	
6562-210	SPRUCE	6'H Board on Board Spruce Backrails Cedar Boards #4 Style Picket Tops Style 210	
8562-210	SPRUCE	8'H Board on Board Spruce Backrails Cedar Boards #4 Style Picket Tops Style 210	

### CEDAR BACKRAILS

Item #	Backrails	Description	Each
3572-210	CEDAR	3'H Board on Board Cedar Backrails Cedar Boards #4 Style Picket Tops Style 210	
4572-210	CEDAR	4'H Board on Board Cedar Backrails Cedar Boards #4 Style Picket Tops Style 210	
5572-210	CEDAR	5'H Board on Board Cedar Backrails Cedar Boards #4 Style Picket Tops Style 210	
6572-210	CEDAR	6'H Board on Board Cedar Backrails Cedar Boards #4 Style Picket Tops Style 210	
8572-210	CEDAR	8'H Board on Board Cedar Backrails Cedar Boards #4 Style Picket Tops Style 210	

### TOPPER

Item #	Description	Each
400-1	12" Height Diamond Tongue and Groove Topper	

### ADDITIONAL OPTIONS

Item #	Description	Each
CD148	1 x 4 x 8 Cedar Board #1	
FASCIA1X4	1 x 4 x 8 Cedar FASCIA Board #1 (IMPORTANT! Fascia boards can be ordered individually or added during the manufacturing process (additional charges may apply). When requesting fascia boards for any section or topper, you must specify the quantity and location (TOP/BOTTOM, FRONT/BACK) at the time of your order.)	

**PLEASE NOTE: ONCE DELIVERED, EASTERN WOOD FENCE IS NON-REFUNDABLE.** Wood fence is a natural product and natural weathering including splitting, warping, twisting, checking, raised grain, swelling, shrinkage, surface mold and/or mildew, fungi, or any other physical property of the wood including but not limited to knots can occur.

# B-on-B - 210 Bottom w/ 800-1 Topper

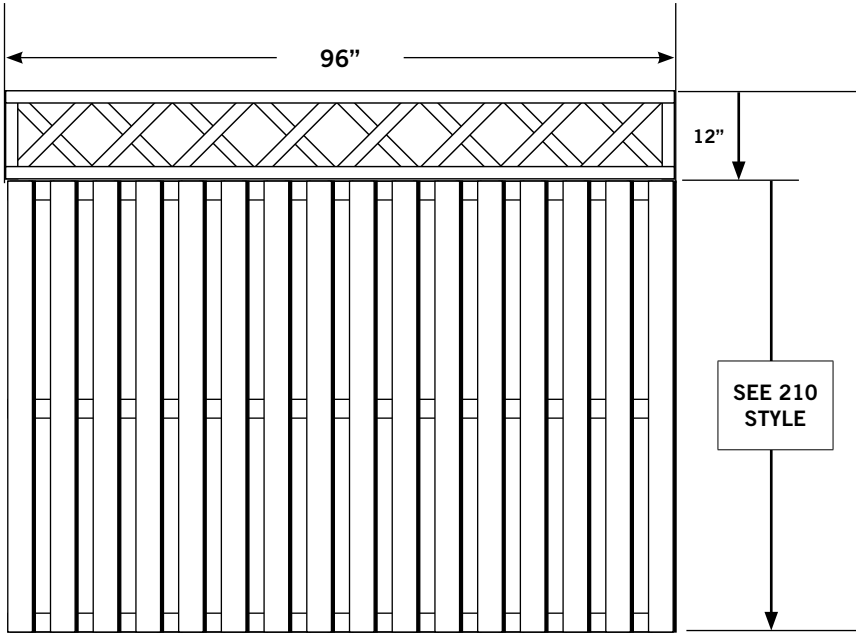

800-1 Lattice Topper

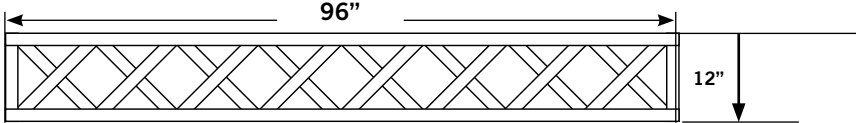

Eastern 800-1 wood fence toppers are made sturdy and strong out of 2" x 3" (nominal) cross-members bailed together by 2" x 3" (nominal) rails. (See lattice top view.)

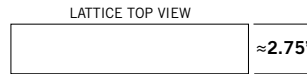

## 210 STYLE BOARD ON BOARD WITH 800-1 TOPPER

3', 4', 5', 6' Height Cedar Board on Board Panel with #5 Style Boards

**BOARDS** STANDARD: Nominal 1" x 4" / 31 Per section. 15 on one side, 16 on the other.  
OPTIONAL: Nominal Red Cedar 1" x 6" x 8" (Call for quote)

**SPACING** Nominal 2-1/2" - 2-3/4" between boards. Boards overlap each other front and back by approx. 1/2". (See top view)

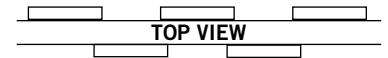

**SPECIES** STANDARD: White Cedar  
OPTIONAL: Red Cedar (Call for Pricing)

**NAILING** Double Nailed Top and Bottom Rails, Single Nailed Middle Rail

**NAILS** Aluminum Spiral Nails

**WIDTH** 96" Wide Actual

**RAILS** STANDARD: 2" x 3" Nominal Cedar  
OPTIONAL: 2" x 3" Nominal Spruce  
OPTIONAL: Dowelled backrails. (Measurements may deviate from standard. Call for pricing and info)

**TO CREATE THIS SECTION, THE BASE, TOPPER, FASCIA, and OPTIONAL CEDAR BOARDS ARE ALL SOLD SEPARATELY**

### 210 STYLE BASE

#### SPRUCE BACKRAILS

Item #	Backrails	Description						Each
3562-210	SPRUCE	3'H	Board on Board	Spruce Backrails	Cedar Boards	#4 Style Picket Tops	Style 210	
4562-210	SPRUCE	4'H	Board on Board	Spruce Backrails	Cedar Boards	#4 Style Picket Tops	Style 210	
5562-210	SPRUCE	5'H	Board on Board	Spruce Backrails	Cedar Boards	#4 Style Picket Tops	Style 210	
6562-210	SPRUCE	6'H	Board on Board	Spruce Backrails	Cedar Boards	#4 Style Picket Tops	Style 210	
8562-210	SPRUCE	8'H	Board on Board	Spruce Backrails	Cedar Boards	#4 Style Picket Tops	Style 210	

#### CEDAR BACKRAILS

Item #	Backrails	Description						Each
3572-210	CEDAR	3'H	Board on Board	Cedar Backrails	Cedar Boards	#4 Style Picket Tops	Style 210	
4572-210	CEDAR	4'H	Board on Board	Cedar Backrails	Cedar Boards	#4 Style Picket Tops	Style 210	
5572-210	CEDAR	5'H	Board on Board	Cedar Backrails	Cedar Boards	#4 Style Picket Tops	Style 210	
6572-210	CEDAR	6'H	Board on Board	Cedar Backrails	Cedar Boards	#4 Style Picket Tops	Style 210	
8572-210	CEDAR	8'H	Board on Board	Cedar Backrails	Cedar Boards	#4 Style Picket Tops	Style 210	

### TOPPER

Item #	Description	Each
800-1	12" Height Criss-Cross Style Topper	

### ADDITIONAL OPTIONS

Item #	Description	Each
CD148	1 x 4 x 8 Cedar Board #1	
FASCIA1X4	1 x 4 x 8 Cedar FASCIA Board #1 (IMPORTANT! Fascia boards can be ordered individually or added during the manufacturing process (additional charges may apply). When requesting fascia boards for any section or topper, you must specify the quantity and location (TOP/BOTTOM, FRONT/BACK) at the time of your order.)	

**PLEASE NOTE: ONCE DELIVERED, EASTERN WOOD FENCE IS NON-REFUNDABLE.** Wood fence is a natural product and natural weathering including splitting, warping, twisting, checking, raised grain, swelling, shrinkage, surface mold and/or mildew, fungi, or any other physical property of the wood including but not limited to knots can occur.

## CUSTOM WOOD - HEAVY LATTICE

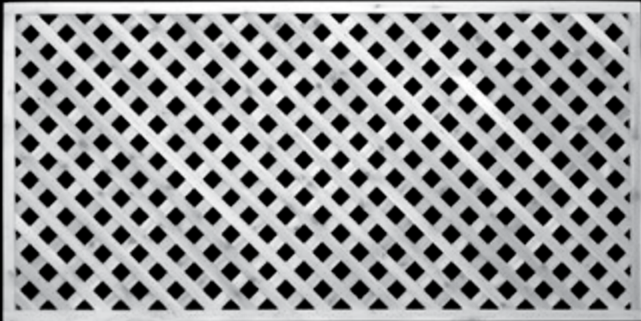

**DIAGONAL LATTICE**

(215-)

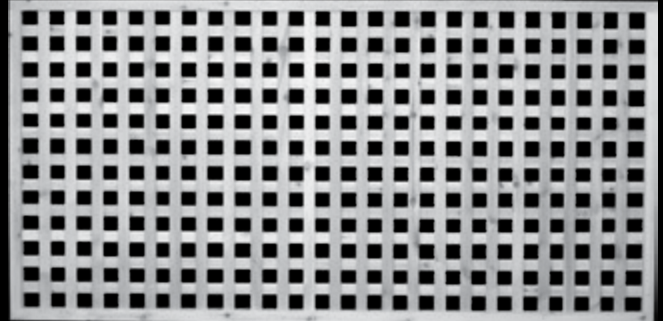

**SQUARE LATTICE**

(SQL-)

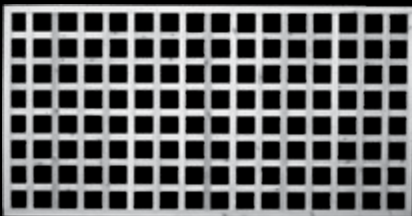

**4" SQUARE**

(SQL4-)

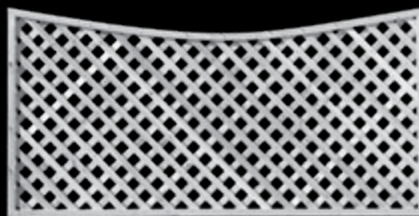

**SCALLOPED**

DIAGONAL

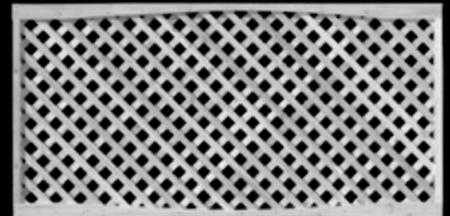

**w/FASCIA**

TOP AND BOTTOM

# HEAVY LATTICE SQUARE LATTICE



## SQL18, SQL28, SQL38, SQL48, SQL58, SQL68

1', 2', 3', 4', 5', 6' Square Heavy Lattice Fence Panels

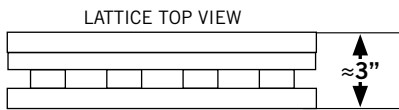
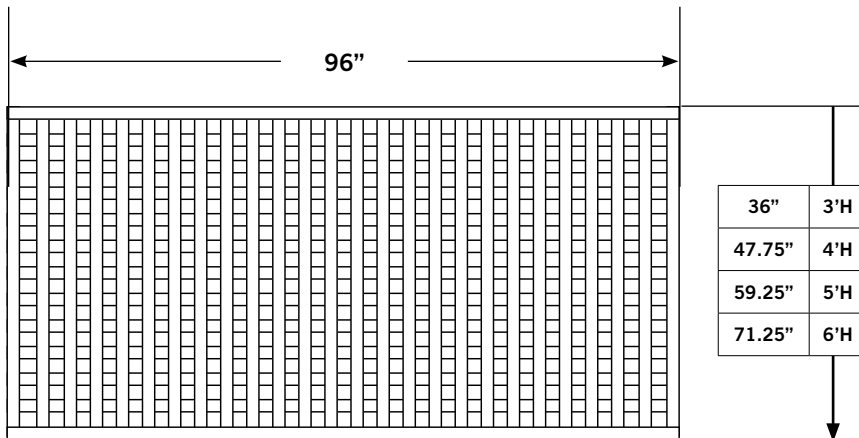

BOARDS	1" x 2"
SPACING:	Between 2" and 2-1/8"
SPECIES:	White Cedar
NAILING:	Nailed and Stapled
NAILS:	Spiral Aluminum Nails/Galv Staples
WIDTH:	96" Actual
RAILS:	All 1" x 2" White Cedar
Optional:	Lattice w/ Fascia Top and Bottom
GATES	Matching gates available. Please CALL for more information

## SQL LATTICE PANEL

Item #	Description	Each
SQL18*	1' H   SQL18 Lattice Panel	<b>STOCKING ITEM</b>
SQL28	2' H   SQL18 Lattice Panel	
SQL38	3' H   SQL18 Lattice Panel	
SQL48	4' H   SQL18 Lattice Panel	
SQL58	5' H   SQL18 Lattice Panel	
SQL68	6' H   SQL18 Lattice Panel	
SQL88	8' H   SQL18 Lattice Panel	

**MATCHING GATES AVAILABLE**

## ADDITIONAL OPTIONS

Item #	Description	Each
FASCIA1X4	1 x 4 x 8 Cedar FASCIA Board #1 (IMPORTANT! Fascia boards can be ordered individually or added during the manufacturing process (additional charges may apply). When requesting fascia boards for any section or topper, you must specify the quantity and location (TOP/BOTTOM, FRONT/BACK) at the time of your order.)	

**PLEASE NOTE: ONCE DELIVERED, EASTERN WOOD FENCE IS NON-REFUNDABLE.**

Wood fence is a natural product and natural weathering including splitting, warping, twisting, checking, raised grain, swelling, shrinkage, surface mold and/or mildew, fungi, or any other physical property of the wood including but not limited to knots can occur.

# HEAVY LATTICE 4" SQUARE LATTICE



## SQL18-4, SQL28-4, SQL38-4, SQL48-4, SQL58-4, SQL68-4

1', 2', 3', 4', 5', 6' Square Heavy 4"

### Lattice Fence Panels

BOARDS 1" x 2"

SPACING: ≈4"

SPECIES: White Cedar

NAILING: Nailed and Stapled

NAILS: Spiral Aluminum Nails/Galv Staples

WIDTH: 96" Actual

RAILS: All 1" x 2" White Cedar

Optional: Lattice w/ Fascia Top and Bottom

GATES Matching gates available. Please CALL for more information

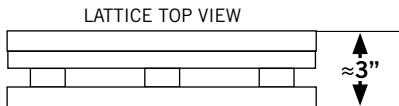
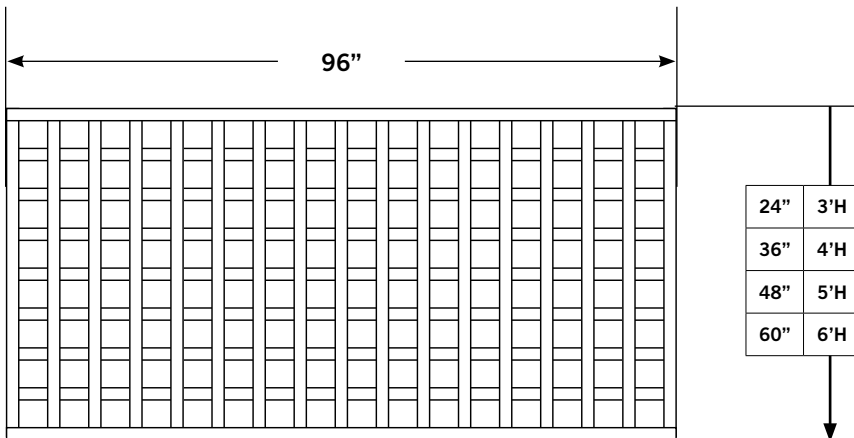

## SQL4 LATTICE PANELS

Item #	Description	Each
SQL18-4	1' H   SQL4 Lattice Panel	
SQL28-4	2' H   SQL4 Lattice Panel	
SQL38-4	3' H   SQL4 Lattice Panel	
SQL48-4	4' H   SQL4 Lattice Panel	
SQL58-4	5' H   SQL4 Lattice Panel	
SQL68-4	6' H   SQL4 Lattice Panel	
SQL88-4	8' H   SQL4 Lattice Panel	

**MATCHING GATES AVAILABLE**

## ADDITIONAL OPTIONS

Item #	Description	Each
FASCIA1X4	1 x 4 x 8 Cedar FASCIA Board #1 (IMPORTANT! Fascia boards can be ordered individually or added during the manufacturing process (additional charges may apply). When requesting fascia boards for any section or topper, you must specify the quantity and location (TOP/BOTTOM, FRONT/BACK) at the time of your order.)	

**PLEASE NOTE: ONCE DELIVERED, EASTERN WOOD FENCE IS NON-REFUNDABLE.**

Wood fence is a natural product and natural weathering including splitting, warping, twisting, checking, raised grain, swelling, shrinkage, surface mold and/or mildew, fungi, or any other physical property of the wood including but not limited to knots can occur.

# HEAVY LATTICE DIAGONAL LATTICE



## 215-1, 215-2, 215-3, 215-4, 215-5, 215-6

1', 2', 3', 4', 5', 6' Diagonal Heavy Lattice Fence Panels

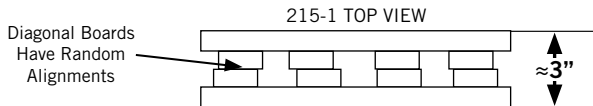
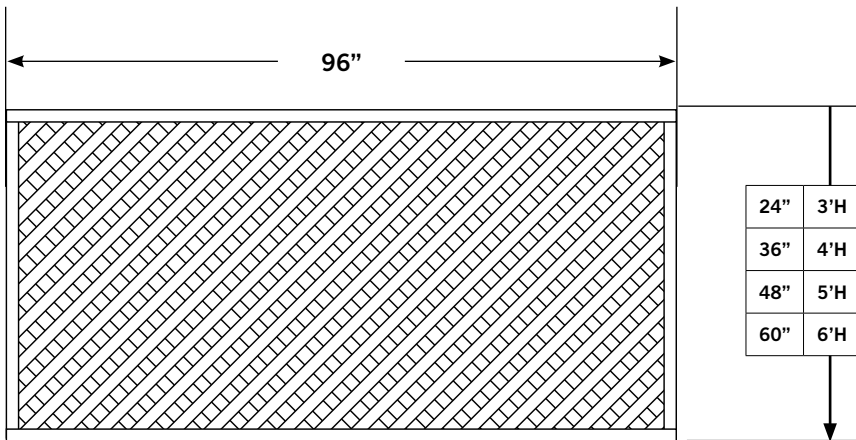

BOARDS	1" x 2"
SPACING:	Between 2" and 2-1/8"
SPECIES:	White Cedar
NAILING:	Nailed and Stapled
NAILS:	Spiral Aluminum Nails/Galv Staples
WIDTH:	96" Actual
RAILS:	All 1" x 2" White Cedar
Optional:	Lattice w/ Fascia Top and Bottom
GATES	Matching gates available. Please CALL for more information

## 215 LATTICE PANELS

Item #	Description	Each
215-1*	1' H   215 Diagonal Lattice Panel	<b>STOCKING ITEM</b>
215-2	2' H   215 Diagonal Lattice Panel	
215-3	3' H   215 Diagonal Lattice Panel	
215-4	4' H   215 Diagonal Lattice Panel	
215-5	5' H   215 Diagonal Lattice Panel	
215-6	6' H   215 Diagonal Lattice Panel	

**MATCHING GATES AVAILABLE**

## ADDITIONAL OPTIONS

Item #	Description	Each
FASCIA1X4	1 x 4 x 8 Cedar FASCIA Board #1 (IMPORTANT! Fascia boards can be ordered individually or added during the manufacturing process (additional charges may apply). When requesting fascia boards for any section or topper, you must specify the quantity and location (TOP/BOTTOM, FRONT/BACK) at the time of your order.)	

**PLEASE NOTE: ONCE DELIVERED, EASTERN WOOD FENCE IS NON-REFUNDABLE.**

Wood fence is a natural product and natural weathering including splitting, warping, twisting, checking, raised grain, swelling, shrinkage, surface mold and/or mildew, fungi, or any other physical property of the wood including but not limited to knots can occur.

# HEAVY LATTICE w/FASCIA TOP AND BOTTOM



## 1', 2', 3', 4', 5', 6' Diagonal Style 215 Heavy Lattice Fence Panels with Fascia Top and Bottom

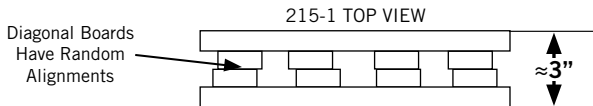
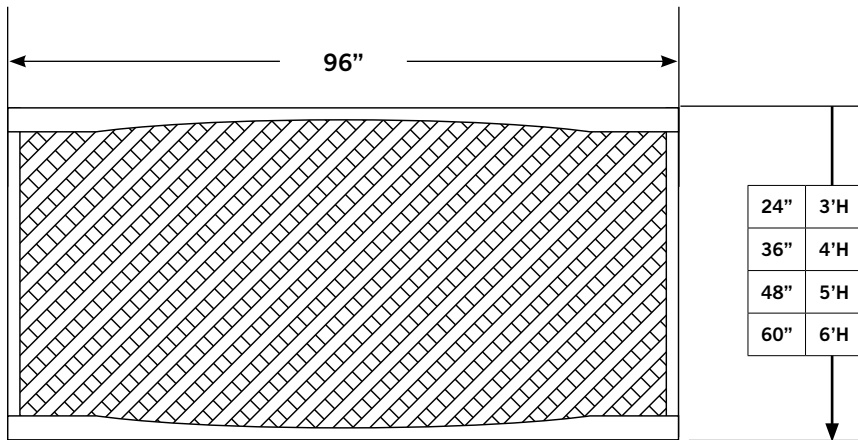

BOARDS	1" x 2"
SPACING:	Between 2" and 2-1/8"
SPECIES:	White Cedar
NAILING:	Nailed and Stapled
NAILS:	Spiral Aluminum Nails/Galv Staples
WIDTH:	96" Actual
RAILS:	All 1" x 2" White Cedar
Optional:	Lattice w/ Fascia Top and Bottom
GATES	Matching gates available. Please CALL for more information

### 215 LATTICE PANELS WITH TOP AND BOTTOM FASCIA BOARDS

Item #	Description	Each
215-1FASCIA	1'H   215 Diagonal Lattice Panel with Top and Bottom Fascia Boards	
215-2FASCIA	2'H   215 Diagonal Lattice Panel with Top and Bottom Fascia Boards	
215-3FASCIA	3'H   215 Diagonal Lattice Panel with Top and Bottom Fascia Boards	
215-4FASCIA	4'H   215 Diagonal Lattice Panel with Top and Bottom Fascia Boards	
215-5FASCIA	5'H   215 Diagonal Lattice Panel with Top and Bottom Fascia Boards	
215-6FASCIA	6'H   215 Diagonal Lattice Panel with Top and Bottom Fascia Boards	
215-8FASCIA	8'H   215 Diagonal Lattice Panel with Top and Bottom Fascia Boards	

**MATCHING GATES AVAILABLE**

**PLEASE NOTE: ONCE DELIVERED, EASTERN WOOD FENCE IS NON-REFUNDABLE.**

Wood fence is a natural product and natural weathering including splitting, warping, twisting, checking, raised grain, swelling, shrinkage, surface mold and/or mildew, fungi, or any other physical property of the wood including but not limited to knots can occur.

# HEAVY LATTICE SCALLOP LATTICE



## 215SCA-1, 215SCA-2, 215SCA-3, 215SCA-4, 215SCA-5, 215SCA-6

1', 2', 3', 4', 5', 6' Scalloped Diagonal  
Heavy Lattice Fence Panels

BOARDS 1" x 2"

SPACING: Between 2" and 2-1/8"

SPECIES: White Cedar

NAILING: Nailed and Stapled

NAILS: Spiral Aluminum Nails/Galv Staples

WIDTH: 96" Actual

RAILS: All 1" x 2" White Cedar

Optional: Lattice w/ Fascia Top and Bottom

GATES Matching gates available. Please CALL  
for more information

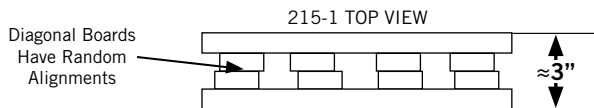
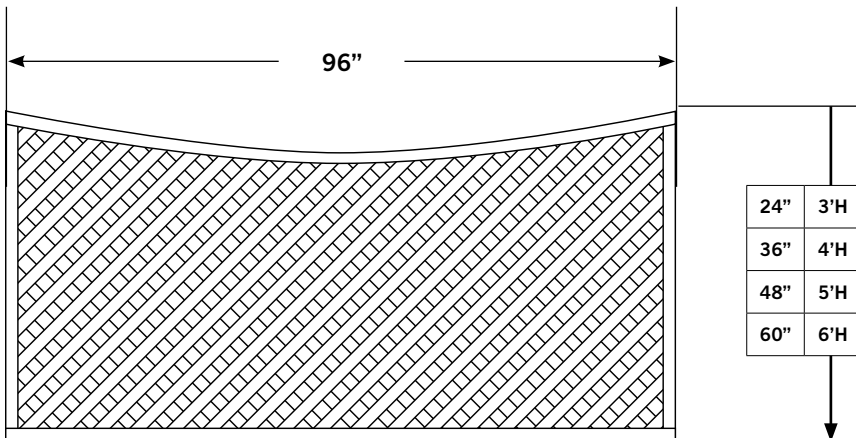

## SCALLOPED 215 STYLE LATTICE PANELS

Item #	Description	Each
215SCA-1	1' H   215 Scalloped Diagonal Lattice Panel	
215SCA-2	2' H   215 Scalloped Diagonal Lattice Panel	
215SCA-3	3' H   215 Scalloped Diagonal Lattice Panel	
215SCA-4	4' H   215 Scalloped Diagonal Lattice Panel	
215SCA-5	5' H   215 Scalloped Diagonal Lattice Panel	
215SCA-6	6' H   215 Scalloped Diagonal Lattice Panel	

**MATCHING  
GATES  
AVAILABLE**

## ADDITIONAL OPTIONS

Item #	Description	Each
FASCIA1X4	1 x 4 x 8 Cedar FASCIA Board #1 (IMPORTANT! Fascia boards can be ordered individually or added during the manufacturing process (additional charges may apply). When requesting fascia boards for any section or topper, you must specify the quantity and location (TOP/BOTTOM, FRONT/BACK) at the time of your order.)	

**PLEASE NOTE: ONCE DELIVERED, EASTERN WOOD FENCE IS NON-REFUNDABLE.**

Wood fence is a natural product and natural weathering including splitting, warping, twisting, checking, raised grain, swelling, shrinkage, surface mold and/or mildew, fungi, or any other physical property of the wood including but not limited to knots can occur.

# DIAMOND POST & RAIL (CEDAR)



## DIAMOND POST AND RAIL - CEDAR (OPTIONAL w/FRENCH GOTHIC TOP POSTS)

Item #	Description	Bundle Qty	Each
C448D	8' 4 x 4 Diamond Rail	121	
C5562HL	2H Line Post Dia 5" x 5" x 6'	81	
C5562HE	2H End Post Dia 5" x 5" x 6'	81	
C5562HC	2H Corner Post Dia 5" x 5" x 6'	81	
C5573HL	3H Line Post Dia 5" x 5" x 7'	81	
C5573HE	3H End Post Dia 5" x 5" x 7'	81	
C5573HC	3H Corner Post Dia 5" x 5" x 7'	81	

## DIAMOND POST AND RAIL GATES

Item #	Description	Bundle Qty	Each
DIAG362R	36" Opening x 2-Rail Diamond Gate	12	
DIAG363R	36" Opening x 3-Rail Diamond Gate	12	
DIAG482R	48" Opening x 2-Rail Diamond Gate	12	
DIAG483R	48" Opening x 3-Rail Diamond Gate	12	
DIAG484R	48" Opening x 4-Rail Diamond Gate	12	
DIAG543R	54" Opening x 4-Rail Diamond Gate	12	
DIAG602R	60" Opening x 2-Rail Diamond Gate	12	
DIAG603R	60" Opening x 3-Rail Diamond Gate	12	
DIAG722R	72" Opening x 2-Rail Diamond Gate	12	
DIAG723R	72" Opening x 3-Rail Diamond Gate	12	
DIAG724R	72" Opening x 4-Rail Diamond Gate	12	

**PLEASE NOTE: ONCE DELIVERED, EASTERN WOOD FENCE IS NON-REFUNDABLE.**

Wood fence is a natural product and natural weathering including splitting, warping, twisting, checking, raised grain, swelling, shrinkage, surface mold and/or mildew, fungi, or any other physical property of the wood including but not limited to knots can occur.

# POST & RAIL (PRESSURE TREATED & WHITE CEDAR)



## Pressure Treated Post & Rail



## WHITE CEDAR

### PRESSURE TREATED SPLIT RAIL (SOUTHERN YELLOW PINE)

Item #	Description	Bundle Qty	Each
PTRL11	11' Long PT Split Rail Southern Yellow Pine Rail With Tapered Ends		
PTRL8	8.5' Long PT Split Rail Southern Yellow Pine Railin with Tapered Ends		
PTSR2HL	2-Hole PT Split Rail Southern Yellow Pine Line Post		
PTSR2HE	2-Hole PT Split Rail Southern Yellow Pine End Post		
PTSR2HC	2-Hole PT Split Rail Southern Yellow Pine Corner Post		
PTSR3HL	3-Hole PT Split Rail Southern Yellow Pine Line Post		
PTSR3HE	3-Hole PT Split Rail Southern Yellow Pine End Post		
PTSR3HC	3-Hole PT Split Rail Southern Yellow Pine Corner Post		
PTSR4HL	4-Hole PT Split Rail Southern Yellow Pine Line Post		
PTSR4HE	4-Hole PT Split Rail Southern Yellow Pine End Post		
PTSR4HC	4-Hole PT Split Rail Southern Yellow Pine Corner Post		

### WHITE CEDAR POST AND RAIL

Full Round Scarf End Rails

Item #	Description	Bundle Qty	Each
CRL	Full Round Rail 10'	150	
C2HL	Cedar 2-Hole Line Post	85	
C2HE	Cedar 2-Hole End Post	85	
C2HC	Cedar 2-Hole Corner Post	85	
C3HL	Cedar 3-Hole Line Post	85	
C3HE	Cedar 3-Hole End Post	85	
C3HC	Cedar 3-Hole Corner Post	85	
CG-42	Cedar 2-Hole Walk Gate 2R x 48"W	10	
CG-52	Cedar 2-Hole Gate 2R x 60"W	10	
CG-43	Cedar 3-Hole Walk Gate 3R x 48"W	10	
CG-53	Cedar 3-Hole Gate 3R x 60"W	10	

\*\*\* DOWEL END CEDAR POST & RAIL AVAILABLE \*\*\*

**PLEASE NOTE: ONCE DELIVERED, EASTERN WOOD FENCE IS NON-REFUNDABLE.**

Wood fence is a natural product and natural weathering including splitting, warping, twisting, checking, raised grain, swelling, shrinkage, surface mold and/or mildew, fungi, or any other physical property of the wood including but not limited to knots can occur.

# SPECIALTY WOOD POST & RAIL

**NEW ITEMS!**



Eastern's *Specialty Wood Post and Rail* is not your normal run-of-the-mill post and rail. **Slip Board Post and Rail Fence** features the flat rail and square post design of a PVC post and rail fence. Additionally, both **Western Red Cedar Post and Rail** and **Pressure Treated Split Rail Southern Yellow Pine** have shown a growing demand in the fencing industry because it delivers the look of a hardwood post and rail yet has some of the best natural weather resistant characteristics available on the market today.

**Please call for quote as these are special order items and have a lead time.**

## WESTERN RED CEDAR POST AND RAIL

Item #	Description	Each
WRCRL	10' Western Red Cedar Rail	
WRC2HL	2-Hole Western Red Cedar Line Post	
WRC2HE	2-Hole Western Red Cedar End Post	
WRC2HC	2-Hole Western Red Cedar Corner Post	
WRC3HL	3-Hole Western Red Cedar Line Post	
WRC3HE	3-Hole Western Red Cedar End Post	
WRC3HC	3-Hole Western Red Cedar Corner Post	



**MATCHING 4' & 5' WIDE GATES AVAILABLE (HARDWARE NOT INCLUDED)**



**NOTE: HDYG48-BK (Heavy duty Yard Guard can be attached to fence with STAPLES-5 for added security)**

## SLIP BOARD POST AND RAIL

Item #	Description	Each
SB1610	Slip Board 1 x 6 x 10 Pressure Treated	
SB3HL	3-Hole PT Slip Board 3 x 6 x 7 Line Post	
SB3HE	3-Hole PT Slip Board 6 x 6 x 8 End Post	
SB3HC	3-Hole PT Slip Board 6 x 6 x 8 Corner Post	
SB4HL	4-Hole PT Slip Board 3 x 6 x 8 Line Post	
SB4HE	4-Hole PT Slip Board 6 x 6 x 8 End Post	
SB4HC	4-Hole PT Slip Board 6 x 6 x 8 Corner Post	



**MATCHING GATES TO FIT 4', 5', & 6' OPENINGS AVAILABLE (INCLUDES HARDWARE)**

**IMPORTANT: WHEN ORDERING, LET SALESPERSON KNOW IF HINGES ARE ON LEFT OR RIGHT**



**SLIP BOARD**

**PLEASE NOTE: ONCE DELIVERED, EASTERN WOOD FENCE IS NON-REFUNDABLE.**

Wood fence is a natural product and natural weathering including splitting, warping, twisting, checking, raised grain, swelling, shrinkage, surface mold and/or mildew, fungi, or any other physical property of the wood including but not limited to knots can occur.

# WOOD POSTS AND CAPS



## .40 ACQ TREATED POSTS

Item #	Description	Bndl. Qty.	Each
ACQ8	ACQ 8' 4 x 4 Flat Top	52	
ACQ9	ACQ 9' 4 x 4 Flat Top	52	
ACQ10	ACQ 10' 4 x 4 Flat Top	52	
ACQ12	ACQ 12' 4 x 4 Flat Top	52	
ACQ558	ACQ 8' 5 x 5 Flat Top	50	
ACQ5510	ACQ 10' 5 x 5 Flat Top	50	
ACQ5512	ACQ 12' 5 x 5 Flat Top	44	
ACQ668	ACQ 8' 6 X 6 Flat Top	32	
ACQ6610	ACQ 10' 6 X 6 Flat Top	32	
ACQ6612	ACQ 12' 6 X 6 Flat Top	32	
FGACQ8	ACQ 8' 4 x 4 French Gothic Top	48	
FGACQ9	ACQ 9' 4 x 4 French Gothic Top	52	
FGACQ10	ACQ 10' 4 x 4 French Gothic Top	48	
FGACQ558	ACQ 8' 5 x 5 French Gothic Top	50	
FGACQ5510	ACQ 10' 5 x 5 French Gothic Top	50	
ACQCH8	ACQ 8' 4 x 4 Chamfered Top	48	
ACQCH10	ACQ 10' 4 x 4 Chamfered Top	48	
ACQCT8	ACQ 8' 4 x 4 Contemporary Top	48	
ACQCT10	ACQ 10' 4 x 4 Contemporary Top	48	
ACQDC8	ACQ 8' 4 x 4 Deco Top	48	
ACQDC10	ACQ 10' 4 x 4 Deco Top	48	

POST STYLES ALSO AVAILABLE IN CEDAR  
(CALL FOR QUOTE)



FLAT



FRENCH GOTHIC



CHAMFERED



CONTEMPORARY



DECO

## EASTERN WHITE CEDAR POSTS

Item #	Description	Bndl. Qty.	Each
C448	Eastern White Cedar 8' 4 x 4	121	
C4410	Eastern White Cedar 10' 4 x 4	121	
C558	Eastern White Cedar 8' 5 x 5	81	
C5510	Eastern White Cedar 10' 5 x 5	81	
C668	Eastern White Cedar 8' 6 x 6	49	
C6610	Eastern White Cedar 10' 6 x 6	49	
C6612	Eastern White Cedar 12' 6 x 6	49	

## DRILLING FOR DOWELLED CONSTRUCTION

ADD THIS AMOUNT TO THE POST COST ABOVE FOR DRILLING FOR DOWELLED CONSTRUCTION

LINES

ENDS

CORNERS

## CEDAR POST CAPS

Item #	Description	Bndl. Qty.	Each
S103P-44	4 x 4 S4S Pyramid Cap	192	
S103F-44	4 x 4 S4S Flat Cap	192	
S103B-44	4 x 4 S4S Ball Cap	25	
S103P-55	5 x 5 S4S Pyramid Cap	72	
S103F-55	5 x 5 S4S Flat Cap	72	
S103B-55	5 x 5 S4S Ball Cap	25	
S103P-66	6 x 6 S4S Pyramid Cap	92	
S103F-66	6 x 6 S4S Flat Cap	92	
S103B-66	6 x 6 S4S Ball Cap	25	



S103P- (PYRAMID)

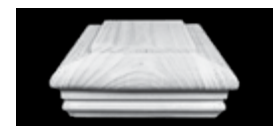

S103F- (FLAT)



S103B- (BALL CAP)

# FENCE BOARDS & BACKRAILS



## FENCE BOARDS (No Wane, No Rot, No Knot Holes)

ITEM #	DESCRIPTION	EACH
CD144	1" x 4" x 4' Cedar Board #1	
CD144-	1" x 4" x 4' Cedar Board #1 TOPPED	
CD144TG	1" x 4" x 4' Cedar Board #1 T&G	
CD145	1" x 4" x 5' Cedar Board #1	
CD145-	1" x 4" x 5' Cedar Board #1 TOPPED	
CD145TG	1" x 4" x 5' Cedar Board #1 T&G	
CD146	1" x 4" x 6' Cedar Board #1	
CD146-	1" x 4" x 6' Cedar Board #1 TOPPED	
CD146TG	1" x 4" x 6' Cedar Board #1 T&G	
CD148	1" x 4" x 8' Cedar Board #1	
CD148-	1" x 4" x 8' Cedar Board #1 TOPPED	
CD148TG	1" x 4" x 8' Cedar Board #1 T&G	

## LOOSE PICKETS - WHITE CEDAR

ITEM #	DESCRIPTION	EACH
CPK4	4' Height Loose Stockade White Cedar Picket	
CPK5	5' Height Loose Stockade White Cedar Picket	
CPK6	6' Height Loose Stockade White Cedar Picket	
CPK8	8' Height Loose Stockade White Cedar Picket	

## LOOSE PICKETS - RED CEDAR

ITEM #	DESCRIPTION	EACH
RCPK4	4' Height Loose 3-1/2" Red Cedar Stockade Picket	
RCPK5	5' Height Loose 3-1/2" Red Cedar Stockade Picket	
RCPK6	6' Height Loose 3-1/2" Red Cedar Stockade Picket	
RCPK8	8' Height Loose 3-1/2" Red Cedar Stockade Picket	
RCVP4	4' Height Loose 2" x 2" Red Cedar Classic Victorian Picket (FLAT TOP)	
RCVP4P	4' Height Loose 2" x 2" Red Cedar Classic Victorian Picket (POINTED TOP)	
RCVP6	6' Height Loose 2" x 2" Red Cedar Classic Victorian Picket (FLAT TOP)	
RCVP6P	6' Height Loose 2" x 2" Red Cedar Classic Victorian Picket (POINTED TOP)	
RCVP8	8' Height Loose 2" x 2" Red Cedar Classic Victorian Picket (FLAT TOP)	
RCVP8P	8' Height Loose 2" x 2" Red Cedar Classic Victorian Picket (POINTED TOP)	

## BACKRAILS - SPRUCE

ITEM #	DESCRIPTION	EACH
S238	Spruce 2" x 3" x 8' Nail On	
SD238	Spruce 2" x 3" x 8' Dowelled	

## BACKRAILS - CEDAR

ITEM #	DESCRIPTION	EACH
C238	Cedar 2" x 3" x 8' Nail On	
CD238	Cedar 2" x 3" x 8' Dowelled	

## BENDS - CEDAR

ITEM #	DESCRIPTION	EACH
WB14RA3	1" x 4" Western Red Cedar 3' Radius	
WB14RA4	1" x 4" Western Red Cedar 4' Radius	
WB14SC8	1" x 4" x 8' Rail 6" Scallop	
WB14SL8	1" x 4" x 8' Straight to Slope 12" Drop	
WB14SLT8-12	1" x 4" x 8' Slope Transition 12" Drop	
WB14SLT8-24	1" x 4" x 8' Slope Transition 24" Drop	
WB14WA8	1" x 4" x 8' Waterfall 12" Drop	

## DOWELLED RAILS

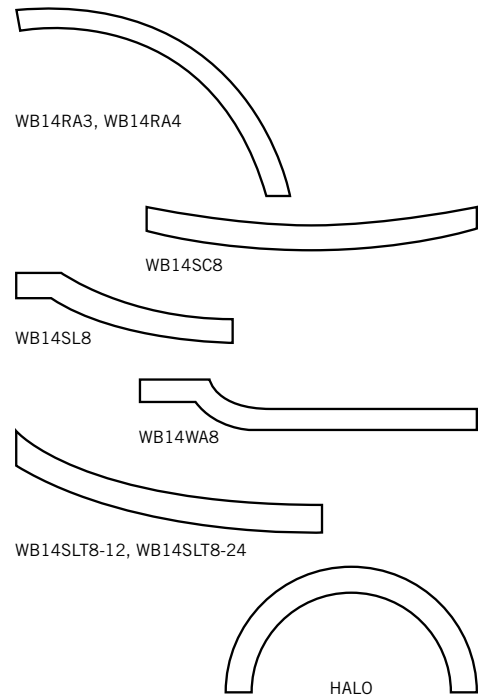

## DADO CAPS

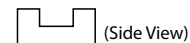

ITEM #	DESCRIPTION	EACH
DAD01X2	1" x 2" x 8' Dado Cap	
DAD01X4	1" x 4" x 8' Dado Cap	
DAD02X3	1" x 3" x 8' Dado Cap	

## FASCIA BOARD

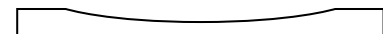

ITEM #	DESCRIPTION	EACH
FASCIA1X4	1 x 4 x 8 Cedar FASCIA Board #1 (IMPORTANT! Fascia boards can be ordered individually or added during the manufacturing process (additional charges may apply). When requesting fascia boards for any section or topper, you must specify the quantity and location (TOP/BOTTOM, FRONT/BACK) at the time of your order.)	

# PRIVACY GATES



## WOOD PRIVACY GATE STYLES

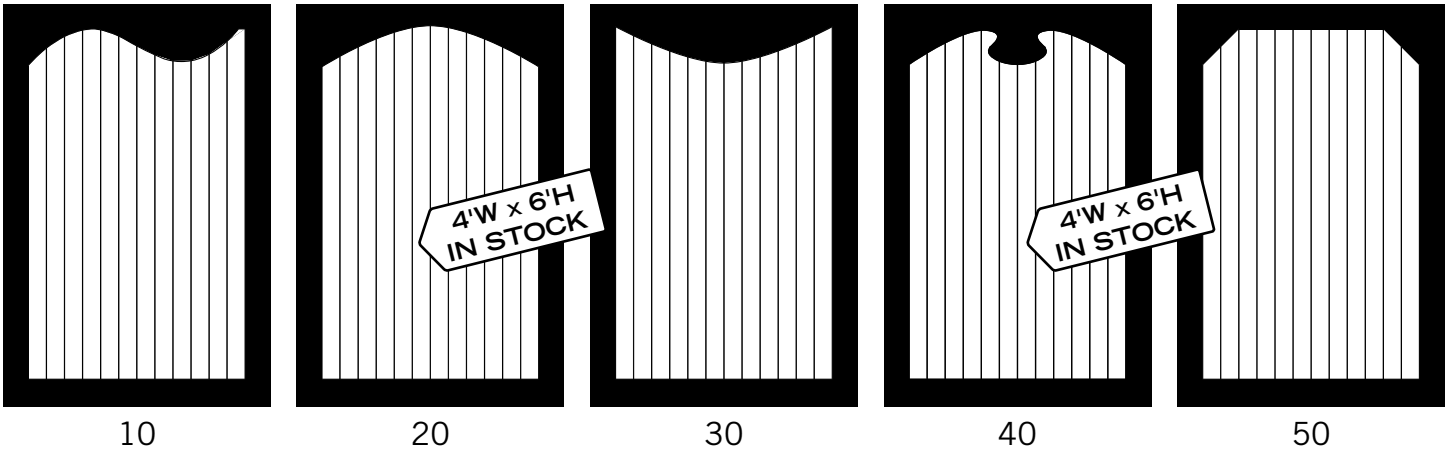

TOP STYLE	Item #	Gate Width	Gate Height	Face boards	Price w/Spruce BR	Price w/Cedar BR
# 10	CWG36-	Actual 36" wide	72" high	#1 White Cedar		
# 20	CWG426-	Actual 42" wide	72" high	#1 White Cedar		
# 30	CWG46-	Actual 48" wide	72" high	#1 White Cedar		
# 40	CDG56-	Actual 60" wide	72" high	#1 White Cedar		
# 50	CDG66-	Actual 72" wide	72" high	#1 White Cedar		

CWG (Cedar Walk Gate) | CDG (Cedar Drive Gate) | Cedar Gates with Cedar backrails (Add the letter "C" to the end of the code for Cedar Backrails, EX: CWG46-20C)

## CUSTOM CEDAR WOOD GATES

- Fabricated with double strength "A" shaped bracing •
- Gate can be hung to open from either side •
- Permits trimming to desired width by cutting same amount off of each side without reducing strength of gate •
  - Hardware not included •
- Custom widths, heights, and styles are available upon request - CALL FOR QUOTE •

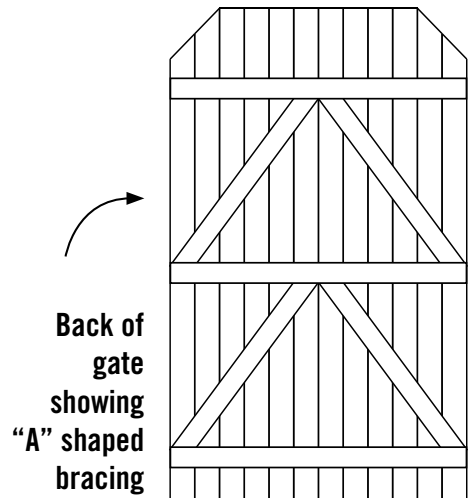

# ARBORS and PERGOLAS



ARB-48 ARCH with  
ARB-LP LATTICE, C448 POSTS



PER4P-4  
ARB-SP LATTICE, C4410 POSTS

Whether framing a gate or a walkway, you can't go wrong with Eastern Wood Fence Arbors & Pergolas. They are the ideal final accents for a beautiful and complete landscape setting.



PER2P  
(SIDE VIEW FROM UNDERNEATH)

## LATTICE SIDE PANELS

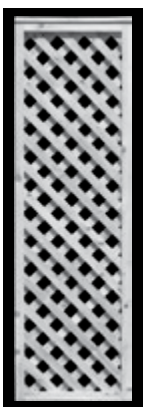

ARB-LP6  
6' Diagonal

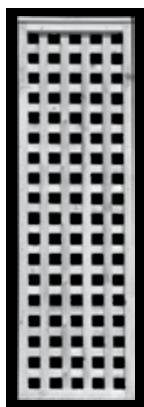

ARB-SP6  
6' Square

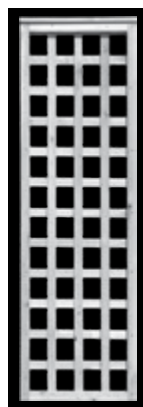

ARB-SP46  
6' Old English

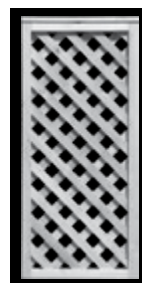

ARB-LP  
4' Diagonal

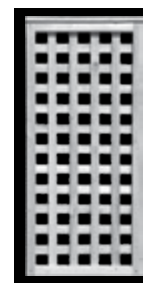

ARB-SP  
4' Square

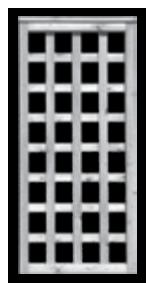

ARB-SP4  
4' Old English

## ARBOR TOPS

(For a Two-Post Arbor, order (1) Halo and (2) C448 Posts)  
(For a Four-Post Arbor, order (1) Arch, (2) Lattice Panels, and (4) C448 Posts)



HALO ONLY  
Includes 1 arch and  
2 Collars



ARCH ONLY  
Includes 2 arches, spindles,  
and 4 collars

Item #	Each	Item #	Each
ARBH-36		ARB-36	
ARBH-42		ARB-42	
ARBH-48		ARB-48	
ARBH-60		ARB-60	
ARBH-72		ARB-72	

## PERGOLA TOPS

(For a 2-Post Pergola, order (1) PER2P- Top and (2) C4410 Posts)  
(For a 4-Post Pergola, order (1) PER4P- Top, (2) Lattice Panels, and (4) C4410 Posts)

Item #	Description	Each	Item #	Description	Each
PER2P-4	2-Post Top		PER4P-4	4-Post Top	
PER2P-5	2-Post Top		PER4P-5	4-Post Top	
PER2P-6	2-Post Top		PER4P-6	4-Post Top	
PER2P-8	2-Post Top		PER4P-8	4-Post Top	

## POSTS

Item #	Description	Each
C448	4 x 4 x 8 Cedar Post (for Arbors)	
C4410	4 x 4 x 10 Cedar Post (for Pergolas)	

## LATTICE PANELS

(See Below. Order (2) Per Arbor or Pergola)

Item #	Description	Each
ARB-LP	4' Height Diag. Lattice Panel	
ARB-SP	4' Height Sq. Lattice Panel	
ARB-SP4	4' Height Old English Lattice Panel	
ARB-LP6	6' Height Diag. Lattice Panel	
ARB-SP6	6' Height Sq. Lattice Panel	
ARB-SP46	6' Height Old English Lattice Panel	

# STANDARD POST TOP FINIALS



These gorgeous finials have been fabricated from laminated, kiln-dried lumber for lasting stability in exterior environments. (As with any laminated wood product, they require a proper finish before installation.)

**NEW ITEMS**



(Each finial comes with dowel screw)



4" Diameter Finial Shown with Cap for 4" Post



4" Diameter Finial Shown with Cap for 5" Post

Available in Spanish Cedar or Mahogany

F100		F101		F102		F103	
Overall Diameter	Price Each	Overall Diameter	Price Each	Overall Diameter	Price Each	Overall Diameter	Price Each
4" (SHOWN)		4" (SHOWN)		4" (SHOWN)		4" (SHOWN)	
5"		5"		5"		5"	
6"		6"		6"		6"	
8"		8"		8"		8"	









F104		F105		F106		F107	
Overall Diameter	Price Each	Overall Diameter	Price Each	Overall Diameter	Price Each	Overall Diameter	Price Each
4" (SHOWN)		4" (SHOWN)		4" (SHOWN)		4" (SHOWN)	
5"		5"		5"		5"	
6"		6"		6"		6"	
8"		8"		8"		8"	

These post top finials are non-stock items. Please allow time for delivery.

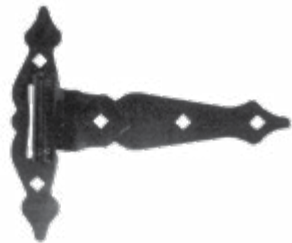
# GATE HARDWARE HINGES







## HINGES

Item #	Description	Case Qty	Each
HT1108B	8" Tee Black	20	
HT9012B	12" Tee Black	20	
HSS1608B Black	8" Twin Strap	20	
HSL1508B Black	8" Spring Load Tee	20	
HBH7012B Black	12" Bolt Hook/Strap	10	
HSH2008B Black	8" Screw Hook & Strap	20	
HSE5000C	Screw Hook & Eye Cadmium (1/2" x 4")	50	
HSE6000C	Screw Hook & Eye Cadmium (5/8" x 5")	20	

# GATE HARDWARE LATCHES

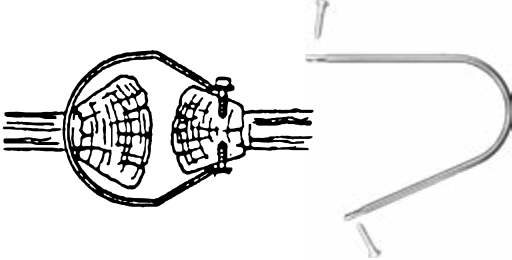

## LATCHES

Item #	Description	Case Qty	Each
WGL	Hatchet Latch Black	20	
GLT200B	Thumb Latch Black 7" Lever	25	
V21A	Universal Floating Gravity Latch - BK	50	
V23A	Heavy Duty Gravity Floating Latch - BK	25	
SBI - 307C	Slide Bolt Latch - Black	60	
GL9	Split Rail Loop Latch Cadmium	60	

# GATE HARDWARE MISCELLANEOUS



## MISCELLANEOUS

Item #	Description	Case Qty	Each
--------	-------------	----------	------

CSB-12	12" Spring Closer - Black	40	
--------	---------------------------	----	--



SR1	Gate Sag Kit	50	
-----	--------------	----	--

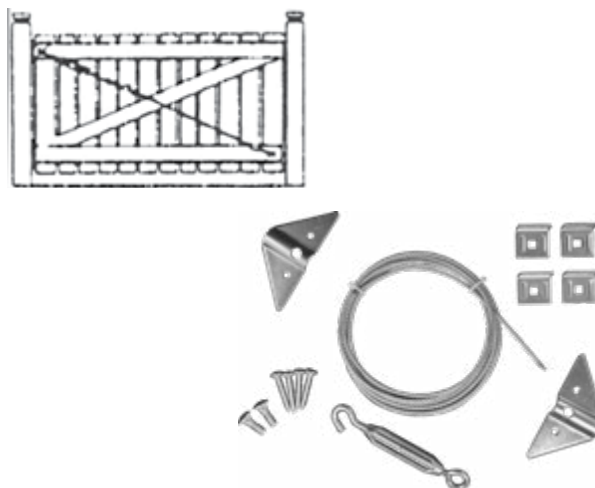

GL201B	Gate Pull - Black	100	
--------	-------------------	-----	--



CBD5024B	24" Deluxe Cane Bolt Black	20	
----------	----------------------------	----	--



# GATE HARDWARE MISCELLANEOUS



## WOOD TO STEEL ADAPTORS

Item #	Size	Case Qty	Each	Case Each
WTS200	Wood to Steel Adaptor For 2" O.D. Steel Pipe	100		
WTS250	Wood to Steel Adaptor For 2-1/2" O.D. Steel Pipe	100		
WTS300	Wood to Steel Adaptor For 3" O.D. Steel Pipe	100		



## NAILS AND STAPLES

Item #	Size	Case Qty	Each	Case Each
SPK20	20D Box	50 LBS.		
SPK30	30D Box	50 LBS.		
SPK40	40D Box	50 LBS.		
SPK305	30D Spikes	5 LB. BAGS		
STAPLES-5	9 x 1-1/2"	5LB. BAGS		
STAPLES	9 x 1-1/2"	50 LB. CASE		



## LAG BOLTS

Item #	Size	Case Qty	Each	Case Each
LAGS	5/16" x 1-1/2" Lag Bolts (100 pcs. per box)	20		



# ORNAMENTAL GATE HARDWARE



## OLD FASHIONED

Item #	Size	Case Qty	Each	Case Each
--------	------	----------	------	-----------

OF18	16" Heavy Duty Hinge - Black	10		
------	------------------------------	----	--	--



OF24	24" Heavy Duty Hinge - Black	10		
------	------------------------------	----	--	--



PH6	Pintle Hinge 6"	20		
-----	-----------------	----	--	--



OFTR	Twisted Ring Latch - Black	10		
------	----------------------------	----	--	--

OFBC	Ball and Chain Closer - Black	10		
------	-------------------------------	----	--	--

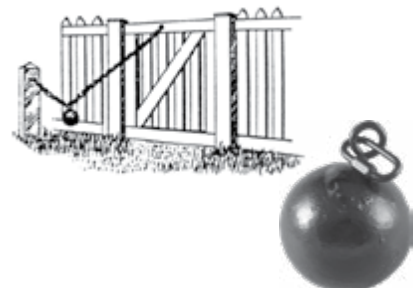



*"Just Built Better..."*



Phone: 800-339-3362 | [www.EasternWoodFence.com](http://www.EasternWoodFence.com)

©Eastern Wholesale Fence LLC • All Rights Reserved